



SKILLER

SGK50S4

MECHANICAL GAMING KEYBOARD

Manual • Anleitung • Manuel • Manuale dell'utente
Handleiding • Instrukcja • Útmutató • Příručka
Руководство пользователя • El Kitabı • 使用説明 • マニュアル

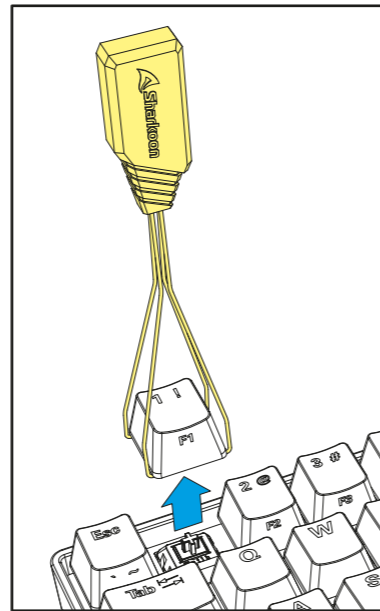
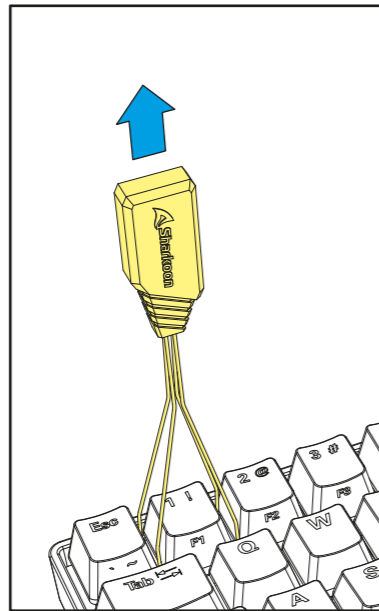
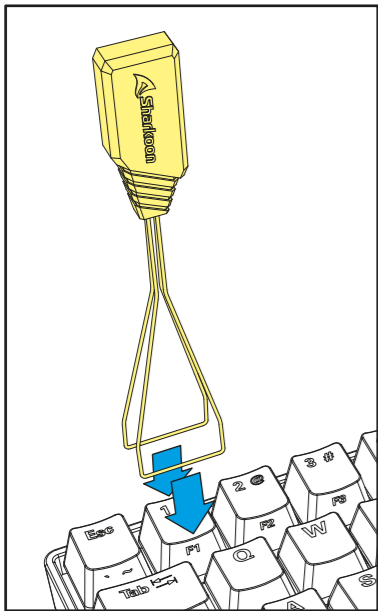

EN

Before removing a switch, first remove the keycap. To do this, place the arms of the keycap puller tool either to the left and right or to the top and bottom of the keycap, and then pull the keycap upwards with careful but constant pressure. Whenever possible, avoid pulling the keycaps from the switch directly with your fingers, as this may damage the switch.

DE

Um Schalter auszubauen, entfernen Sie bitte zunächst die Tastenkappe. Platzieren Sie dazu den Tastenkappenzieher mit beiden Armen entweder jeweils zur linken und rechten oder oberen und unteren Seite der Kappe, und ziehen Sie danach die Kappe mit vorsichtigem aber beständigem Druck nach oben. Vermeiden Sie es nach Möglichkeit, die Tastenkappen mit bloßen Fingern vom Schalter zu ziehen, da auf diese Weise Beschädigungen am Schalter nicht ausgeschlossen sind.

FR

Avant de retirer un commutateur, retirez d'abord le capuchon de la touche. Pour ce faire, placez les bras de l'outil d'extraction de capuchons soit à gauche et à droite, soit en haut et en bas du capuchon de touche, puis tirez le capuchon de touche vers le haut en exerçant une pression prudente mais constante. Si possible, évitez de tirer les capuchons du commutateur directement avec vos doigts, car cela pourrait endommager le commutateur.

IT

Prima di rimuovere uno switch, è necessario rimuovere il copritasto. Per farlo, posiziona i braccetti della pinza per estrarre i copritasti a sinistra e a destra o nella parte superiore e inferiore del copritasto e tiralo verso l'alto con cautela, ma con una pressione costante. Se possibile, evita di estrarre il copritasto dello switch direttamente con le dita, poiché il processo potrebbe danneggiare lo switch.

ES

Antes de extraer un interruptor, primero extraiga el casquete de tecla. Para ello, posicione los brazos del extractor de casquetes a la izquierda y derecha, o bien en la parte superior y la inferior del casquete, y luego extraiga el casquete hacia arriba con cuidado, pero ejerciendo una presión constante. Cuando sea posible, evite extraer los casquetes del interruptor directamente con sus dedos, pues esto podría dañar el interruptor.

PT

Antes de remover uma chave, primeiro remova a tampa da tecla. Para fazer isso, coloque os braços da ferramenta extratora de tecla à esquerda e à direita ou na parte superior e inferior da tecla e, em seguida, puxe a tampa para cima com pressão cuidadosa, mas constante. Sempre que possível, evite puxar as teclas do switch diretamente com os dedos, pois isso pode danificar o switch.

NL

Voordat je een schakelaar verwijdert, verwijder je eerst de keycap. Plaats hiervoor de poten van de keycap puller tool aan de linker- en rechterkant of aan de boven- en onderkant van de keycap, en trek de keycap vervolgens met voorzichtige, maar constante kracht omhoog. Probeer indien mogelijk te voorkomen dat je de keycaps direct met je vingers uit de schakelaar trekt, want dit kan de schakelaar beschadigen.

PL

Przed wyjęciem przełącznika najpierw zdejmij nasadkę klawiszy. Aby to zrobić, umieść ramiona narzędzia do wyciągania nasadek klawiszy z lewej i prawej strony lub u góry i u dołu nasadki przycisków, a następnie pociągnij nasadkę w górę z ostrożnym, ale stałym naciskiem. Jeśli to możliwe, unikaj wyciągania nasadek klawiszy bezpośrednio z przełącznika palcami, ponieważ może to spowodować uszkodzenie przełącznika.

HU

A kapcsoló eltávolítása előtt távolítsd el a billentyűt. Ehhez illeszd a billentyű-kiszedő eszköz karjait a billentyű jobb és bal vagy felső és alsó oldalára, majd óvatosan, de folyamatos erővel húzd felfelé az eszközzel a billentyűt. Lehetőség szerint ne közvetlenül az ujjaiddal húzd ki a billentyűket, mert attól károsodhatnak alattuk a kapcsolók.

CZ

Před odstraněním spínače nejdříve vyjměte klávesu. To uděláte tak, že umístíte ramena kleští na klávesy buď na levou a pravou, anebo na horní a dolní stranu klávesy a pak vytáhnete klávesu směrem vzhůru opatrným, ale stálým tlakem. Kdykoliv to bude možné, nesnímejte klávesy ze spínačů pomocí prstů, protože by se spínač mohl poškodit.

RU

Перед снятием переключателя сначала снимите колпачок с клавиатуры. Для этого поместите ключ для снятия колпачков клавиатуры либо слева и справа, либо сверху и снизу колпачка, а затем осторожно, но с постоянным давлением потяните крышку вверх. По возможности старайтесь не снимать колпачки с переключателя пальцами, так как это может повредить переключатель.

TR

Bir anahtar çıkarmadan önce klavye kapağını çıkarın. Bunu yapmak için, klavye tuş çıkartma aletinin kollarını tuş kapağının soluna ve sağına veya üstüne ve altına yerleştirin ve ardından tuş başlığını dikkatli ancak sabit bir basınçla yukarı doğru çekin. Anahtara zarar verebileceğinden, mümkün olduğunda tuş kapaklarını doğrudan parmaklarınızla anahtardan çekmekten kaçının.

CN

在移除軸體之前，要先取下鍵帽，將拔鍵器分別從左右或上下兩側夾住，再小心地用穩定的力道將鍵帽向上拔除，盡可能避免用手指直接從軸體上拔除鍵帽，以免損壞軸體。

JP

スイッチを取り外す前に、まずキーキャップを取り外しましょう。こちらを行うために、キーキャッププラーツールのアームを左右もしくは上下に配置させ、一定の力で注意深く上に引き上げてください。

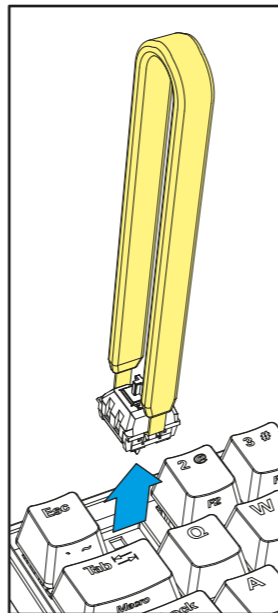
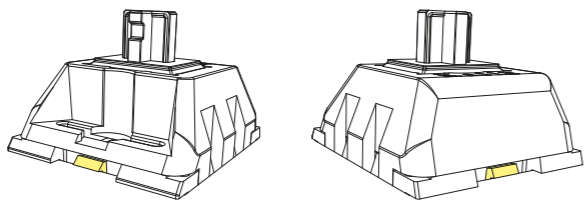
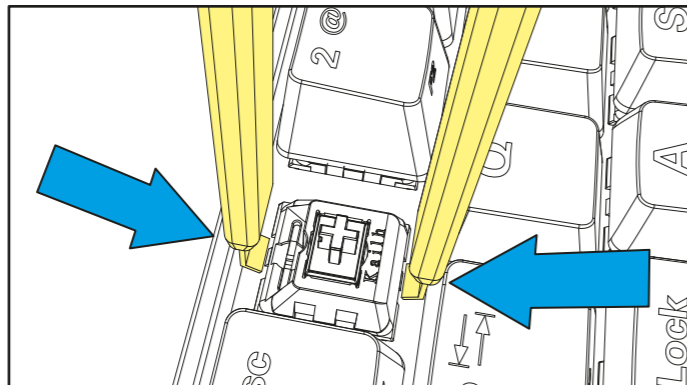
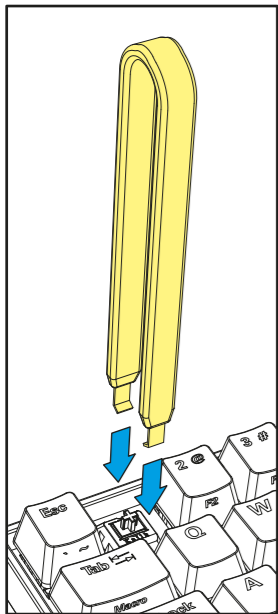

EN

Once you have removed the keycap from the switch, position the switch puller tool correctly on the tabs of the switch. These are positioned to the front and the back of the switch. Before pulling out the switch, make sure that both tabs are securely pressed with the switch puller tool and that the switch can be removed from the socket without resistance. If necessary, remove the adjacent keycaps to allow the switch puller tool sufficient freedom of movement. After you have removed the keycap, press both tabs of the switch with the switch puller tool and then slowly pull the switch out of the socket. Be sure to always pull vertically from the socket with a straight, upward direction. Avoid pulling in a slanted direction, as this can result in damage.

DE

Sobald Sie die Tastenkappe vom Schalter entfernt haben, positionieren Sie den Switch-Puller korrekt an den Füßen. Diese befinden sich auf der Ober- und Unterseite des Schalters. Stellen Sie außerdem vor dem Herausziehen des Schalters sicher, dass beide Füße sicher mit dem Switch-Puller gedrückt wurden und sich der Schalter ohne Widerstand aus der Fassung entnehmen lässt. Entfernen Sie gegebenenfalls die angrenzenden Tastenkappen, um dem Switch-Puller genügend Bewegungsspielraum einzuräumen. Sobald Sie die Tastenkappe entfernt haben, drücken Sie mit dem Switch-Puller die beiden Füße des Schalters, und ziehen Sie den Schalter danach langsam aus der Fassung heraus. Bewahren Sie auch dabei stets einen senkrechten Zug nach oben. Vermeiden Sie schräge Bewegungen, da auf diese Weise Beschädigungen auftreten können.

FR

Une fois que vous avez retiré le capuchon du commutateur, positionnez correctement l'outil d'extraction de commutateur sur les languettes du commutateur. Celles-ci sont positionnées à l'avant et à l'arrière du commutateur. Avant de retirer le commutateur, assurez-vous que les deux languettes soient bien enfoncées avec l'outil d'extraction de commutateur et que le commutateur puisse être retiré du circuit sans résistance. Si nécessaire, retirez les capuchons de touche adjacents pour permettre à l'outil d'extraction de commutateur une liberté de mouvement suffisante. Après avoir retiré le capuchon de la touche, appuyez sur les deux languettes du commutateur avec l'outil d'extraction de commutateur, puis retirez lentement le commutateur du circuit. Assurez-vous de toujours tirer verticalement par rapport au circuit avec une direction droite vers le haut. Évitez de tirer dans une direction inclinée, car cela peut entraîner des dommages.

IT

Una volta rimosso il copritasto, posiziona la pinza per estrarre gli switch esattamente sulle linguette dello switch. Queste ultime si trovano nella parte anteriore e posteriore dello switch. Prima di estrarre lo switch, assicurati che la pressione della pinza per estrarre gli switch sulle linguette sia ben salda e che lo switch possa essere rimosso dall'attacco senza resistenze. Se necessario, rimuovi i copritasti adiacenti per permettere alla pinza per estrarre gli switch la sufficiente libertà di movimento. Dopo aver rimosso il copritasto, premi entrambe le linguette dello switch con la pinza per estrarre gli switch e rimuovi lentamente lo switch dall'attacco. Assicurati sempre di effettuare un'estrazione verticale e diretta verso l'alto. Un'eventuale estrazione effettuata in senso obliquo può provocare danni.

ES

Una vez extraído el casquete del interruptor, posicione el extractor de interruptores correctamente sobre las pestañas del interruptor. Estos están posicionados en la parte frontal y trasera del interruptor. Antes de extraer hacia arriba el interruptor, asegúrese de que ambas pestañas están presionadas con seguridad con el extractor de interruptores y que el interruptor se puede retirar de la cavidad sin resistencia. Si es necesario, retire los casquetes contiguos para permitir libertad de movimiento al extractor de interruptores. Después de haber retirado el casquete, presione ambas pestañas del interruptor con el extractor de interruptores y luego extraiga despacio el interruptor de la cavidad. Asegúrese de que siempre extrae verticalmente en dirección hacia arriba desde la cavidad. Evite extraer en una dirección inclinada, esto puede provocar daños.

PT

Depois de remover a tampa da chave, posicione a ferramenta extratora de chave corretamente nas guias da chave. Eles são posicionados na parte frontal e posterior do switch. Antes de puxar o interruptor, certifique-se de que ambas as abas estão firmemente pressionadas com a ferramenta extrator de interruptor e que o interruptor pode ser removido do soquete sem resistência. Se necessário, remova as tampas da chave adjacentes para permitir ao extrator de chave liberdade de movimento suficiente. Depois de remover a tampa da chave, pressione ambas as guias da chave com a ferramenta extrator de chave e, em seguida, puxe lentamente a chave para fora do soquete. Certifique-se de sempre puxar verticalmente do soquete com uma direção reta para cima. Evite puxar em uma direção inclinada, pois isso pode resultar em danos.

NL

Als je de keycap uit de schakelaar hebt verwijderd, plaats je de switch puller tool precies op de tabjes van de schakelaar. Die vind je aan de voor- en achterkant van de schakelaar. Zorg dat je de switch puller tool goed tegen de beide tabjes aangedrukt houdt en dat de schakelaar zonder weerstand uit de toetsopening kan worden verwijderd, voordat je de schakelaar eruit trekt. Verwijder desnoods de omliggende keycaps, zodat de switch puller tool voldoende bewegingsruimte heeft. Nadat je de keycap hebt verwijderd, duw je met de switch puller tool tegen beide tabjes op de schakelaar en trek je de schakelaar langzaam uit de opening. Zorg dat je de schakelaar altijd met een rechte, opwaartse beweging verticaal uit de opening trekt. Trek niet in een schuine richting, want dit kan schade veroorzaken.

PL

Po wyjęciu nasadki klawiszy z przełącznika należy prawidłowo ustawić narzędzie do wyjmowania switchy na zaczepach przełącznika. Są one umieszczone z przodu i z tyłu przełącznika. Przed wyciągnięciem przełącznika upewnij się, że oba zaczepy są mocno dociśnięte za pomocą narzędzia do ściągania przełącznika i że przełącznik można wyjąć z gniazda bez oporu. W razie potrzeby zdejmij sąsiednie nasadki klawiszy, aby umożliwić narzędziu do ściągania przełączników wystarczającą swobodę ruchu. Po zdjęciu nasadki klawisza naciśnij oba zaczepy przełącznika za pomocą narzędzia do ściągania przełącznika, a następnie powoli wyciągnij przełącznik z gniazda. Pamiętaj, aby zawsze ciągnąć pionowo z gniazda w kierunku prostym do góry. Unikaj ciągnięcia pod kątem, ponieważ może to spowodować uszkodzenie.

HU

Miután levetted a billentyűt a kapcsolóról, helyezd a kapcsolóhúzó eszközt megfelelően a kapcsoló fölére. Ezek a kapcsoló elülső és hátsó részén vannak elhelyezve. A kapcsoló kihúzása előtt ellenőrizze, hogy mindkét fül megfelelően le van-e nyomva a kapcsolóhúzó eszközzel, és hogy a kapcsoló ellenállás nélkül eltávolítható-e az aljzatból. Szükség esetén vedd le a szomszédos billentyűket, hogy szabadabban mozoghass a kapcsolóhúzó eszközzel. Miután eltávolítottad a billentyűt, nyomd le a kapcsoló mindkét fülét a kapcsolóhúzó eszközzel, majd lassan húzd ki a kapcsolót az aljzatból. Ügyelj rá, hogy mindig függőlegesen húzd ki az aljzatból, egyenesen felfelé. Kerüld a ferdén történő kihúzást, mert a kapcsoló megsérülhet.

CZ

Po sejmutí klávesy ze spínače umístěte správným způsobem kleště na spínače na drážky spínače. Ty se nacházejí v přední a zadní části spínače. Před vytáhnutím spínače si zkontrolujte, jestli kleště na spínače dobře svírají drážky a jestli může být spínač odejmut z lůžka, aniž by kladl odpor. Pokud je to nezbytné, odstraňte sousední klávesy, aby měly kleště na spínače více prostoru. Po odejmutí klávesy stiskněte obě drážky spínače kleštěmi na spínače a pak spínač pomalu vytáhněte z lůžka. Nezapomeňte tahat spínač z lůžka vertikálně, směrem přímo vzhůru. Nevytahujte spínač v šikmém směru, protože by se mohl poškodit.

RU

После того, как вы сняли колпачок с переключателя, правильно установите съёмник переключателя на выступы переключателя. Они расположены спереди и сзади переключателя. Перед тем, как вытащить переключатель, убедитесь, что оба язычка надёжно нажаты съёмником переключателя и что его можно вынуть из разъёма без сопротивления. При необходимости снимите соседние колпачки клавиш, чтобы инструмент для снятия переключателя мог свободно перемещаться. После того, как вы сняли колпачок клавиатуры, нажмите на оба язычка переключателя с помощью съёмника переключателя, а затем медленно вытащите переключатель из разъёма. Всегда вытягивайте из гнезда вертикально, направляя его прямо вверх. Избегайте натяжения в наклонном направлении, так как это может привести к повреждению.

TR

Tuş kapağını anahtardan çıkardıktan sonra, anahtar çıkartma aletinin anahtarın tırnaklarına doğru şekilde yerleştirin. Bunlar, anahtarın önüne ve arkasına yerleştirilmiştir. Anahtarı çekmeden önce, anahtar çıkartma aleti ile her iki tırnağın da sağlam bir şekilde bastırıldığından ve anahtarın direnç göstermeden soketten çıkarılabildiğinden emin olun. Gerekirse, anahtar çıkartma aracına yeterli hareket serbestliği sağlamak için bitişik tuş başlıklarını çıkarın. Tuş kapağını çıkardıktan sonra, anahtarın her iki tırnağına da anahtar çekme aracıyla basın ve ardından anahtarı yavaşça soketten çekin. Soketten daima düz, yukarı yönde dikey olarak çektiğinizden emin olun. Hasara neden olabileceğinden, eğimli bir yönde çekmekten kaçının.

CN

取下鍵帽後，將拔軸器正確地放置在位於軸體前後方的卡榫上，使用拔軸器前確認將其牢固地按下卡榫，拔軸器就可毫無阻力地將軸體由插座中取出，如有必要，可移除相鄰的鍵帽，讓拔軸器使用的空間更加充足。取下鍵帽後，使用拔軸器按住兩側卡榫，將軸體慢慢取出。請務必由垂直的方向從插座中拉出，避免往斜向拉動而導致損壞。

JP

スイッチを引き抜く前に、両方のタブをスイッチプラーツールでしっかりと押されているか、スイッチが抵抗なく取り外せるかをご確認ください。もし必要であれば、スイッチプラーツールが自由に動けるように隣接するキーキャップを取り外しましょう。キーキャップを取り外したら、スイッチプラーツールでスイッチの両方のタブを押しソケットからゆっくりとスイッチを引き上げましょう。斜め方向に引っ張ると損傷をするため、必ずソケットを真っ直ぐ、垂直に引っ張ってください。

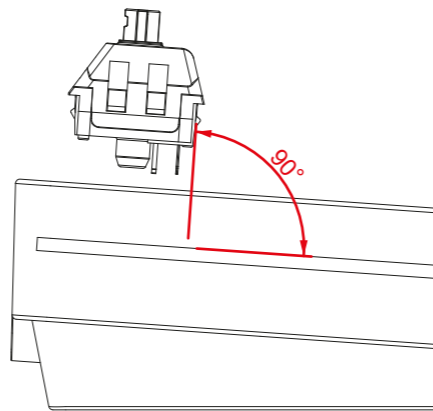
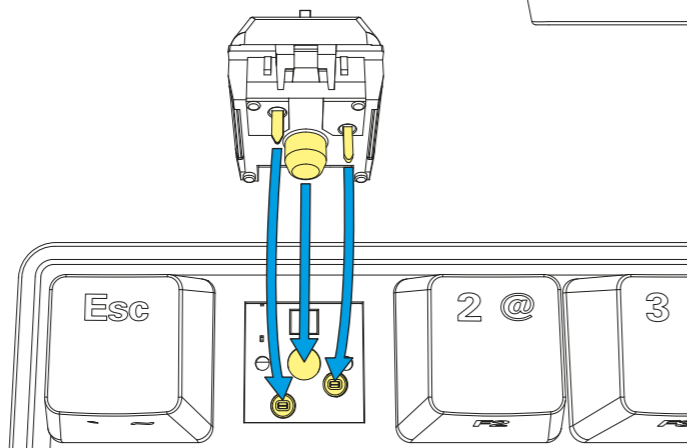
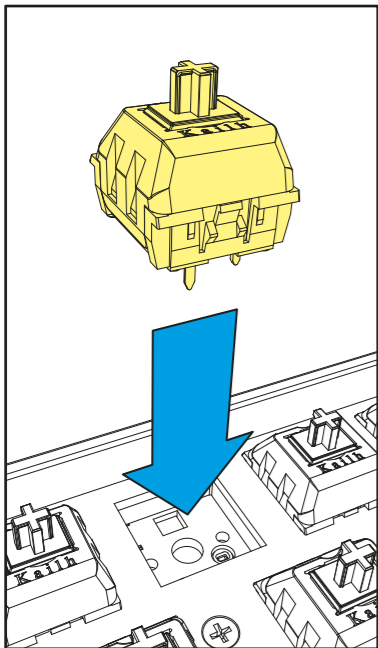

EN

To install the switches, position the switch so that one tab is at the front and the other tab is at the back. Each pin on the underside of the switch should be pointing exactly to its relevant contact in the keyboard socket. Make sure that the switch is led vertically into the socket opening (at a 90-degree angle to the socket). Installing the switch incorrectly can lead to damage or malfunction of the switch. After you have placed the switch in its socket, push very gently on the switch to secure it in place. Make sure that you do not use too much force, as this can damage or destroy fragile components.

DE

Um Schalter einzubauen, platzieren Sie den Schalter bitte mit den Füßen jeweils nach vorne und hinten deutend, sodass die Pins auf der Unterseite des Schalters exakt auf die Kontakte deuten. Beachten Sie dabei, dass der Schalter senkrecht in einem Winkel von 90 Grad zum Steckplatz geführt wird. Etwaige Fehlplatzierungen können zu Beschädigungen oder einem nicht-Funktionieren des Schalters führen. Nachdem Sie den Schalter auf seinem Steckplatz platziert haben, befestigen Sie ihn bitte mit sanftem Druck in seiner Fassung. Beachten Sie dabei, dass Sie nicht zu viel Kraft aufwenden, da auf diese Weise zerbrechliche Bauteile beschädigt oder zerstört werden können.

FR

Pour installer les commutateurs, positionnez le commutateur de sorte qu'une languette soit à l'avant et l'autre languette à l'arrière. Chaque broche sur la face inférieure du commutateur doit pointer exactement vers son contact correspondant dans le circuit du clavier. Assurez-vous que le commutateur soit dirigé verticalement dans l'ouverture du circuit (à un angle de 90 degrés par rapport au circuit). Une installation incorrecte du commutateur peut entraîner des dommages ou un dysfonctionnement du commutateur. Après avoir placé le commutateur dans son circuit, appuyez très doucement sur le commutateur pour le fixer. Assurez-vous que vous n'utilisez pas trop de force, car cela peut endommager ou détruire les composants fragiles.

IT

Per installare uno switch, basta posizionarlo in modo che una linguetta stia nella parte anteriore e l'altra nella parte posteriore. Ogni perno sulla parte inferiore dello switch deve puntare esattamente verso il contatto corrispondente dell'attacco della tastiera. Assicurati che lo switch venga inserito verticalmente nell'attacco (con un angolo di 90 gradi rispetto a esso). L'errata installazione può causare danni o malfunzionamenti dello switch. Dopo aver posizionato lo switch nell'attacco, applica una lieve pressione per fissarlo. Non usare troppa forza per evitare di danneggiare o distruggere le componenti più fragili.

ES

Para instalar los interruptores, posicione el interruptor de modo que una de las pestañas esté ubicada en el frontal y la otra en la parte trasera. Cada pin en el reverso del interruptor debe apuntar exactamente hacia su contacto pertinente en la cavidad del teclado. Asegúrese de que el interruptor está posicionado con el led verticalmente sobre la cavidad (en un ángulo de 90 grados de la cavidad). Instalar el interruptor incorrectamente puede provocar daños o un mal funcionamiento en el propio interruptor. Después de posicionar el interruptor en su cavidad, presione suavemente sobre el interruptor para asegurarlo. No emplee mucha fuerza en ello, pues esto podría dañar o destruir componentes frágiles.

PT

Para instalar os interruptores, posicione o interruptor de forma que uma guia fique na frente e a outra na parte de trás. Cada pino na parte inferior da chave deve apontar exatamente para seu contato relevante no soquete do teclado. Certifique-se de que o interruptor seja direcionado verticalmente para a abertura do soquete (em um ângulo de 90 graus com o soquete). Instalar o interruptor incorretamente pode causar danos ou mau funcionamento. Depois de colocar o interruptor no soquete, empurre com cuidado o interruptor para prendê-lo no lugar. Certifique-se de não usar muita força, pois isso pode danificar ou destruir componentes frágeis.

NL

Om de schakelaars te installeren, plaats je de schakelaar zo dat één tabje aan de voorkant zit en het andere aan de achterkant. Elke pin aan de onderkant an de schakelaar moet precies naar zijn betreffende contact in de opening in het toetsenbord wijzen. Zorg dat de schakelaar verticaal in de opening wordt geplaatst (onder een hoek van 90 graden met de opening). Verkeerde installatie van de schakelaar kan leiden tot schade of verstoorde werking van de schakelaar. Nadat je de schakelaar in zijn opening hebt geplaatst, duw je deze zachtjes aan om hem op zijn plek te bevestigen. Zorg dat je niet te veel kracht gebruikt, want dat kan kwetsbare componenten beschadigen of breken.

PL

Aby zainstalować przełączniki, ustaw przełącznik tak, aby jeden zaczepek znajdował się z przodu, a drugi z tyłu. Każdy pin na spodzie przełącznika powinien wskazywać dokładnie na odpowiedni styk w gnieździe klawiatury. Upewnij się, że przełącznik jest włożony pionowo w otwór gniazdka (pod kątem 90 stopni do gniazdka). Nieprawidłowy montaż przełącznika może prowadzić do uszkodzenia lub nieprawidłowego działania przełącznika. Po umieszczeniu switcha w gnieździe, naciśnij go bardzo delikatnie, aby zabezpieczyć go na miejscu. Upewnij się, że nie używasz zbyt dużej siły, ponieważ może to uszkodzić lub zniszczyć delikatne elementy.

HU

A kapcsolók telepítéséhez úgy állítsd be a kapcsolót, hogy az egyik fül elöl, a másik hátul legyen. A kapcsoló alsó oldalán lévő tűknek pontosan a megfelelő érintkezőre kell mutatnia a billentyűzet foglalatában. Fontos, hogy a kapcsolót függőlegesen helyezd a foglalatnyílásba (90 fokos szögben az aljzathoz képest). A kapcsoló helytelen telepítése a kapcsoló károsodásához vagy meghibásodásához vezethet. Miután a kapcsolót a foglalatába helyezted, nagyon finoman nyomd meg a kapcsolót, így a helyére kattan. Ügyelj rá, hogy ne túl erősen nyomd, mert a törékeny alkatrészek megsérülhetnek vagy tönkremehetnek.

CZ

Spínače nainstalujete tak, že ho umístíte způsobem, kdy jedna drážka je vepředu a druhá drážka vzadu. Každý kolík vespod spínače by měl směřovat přesně k příslušnému kontaktu v lůžku na klávesnici. Zkontrolujte si, jestli spínač směřuje do otvoru lůžka vertikálně (v 90stupňovém úhlu k lůžku). Nesprávná instalace spínače může mít za následek poškození či poruchu spínače. Když spínač umístíte na lůžko, zajistěte ho na místě velmi jemným zatlačením. Nepoužívejte přitom příliš velkou sílu, protože byste mohli poškodit či zničit křehké součástky.

RU

Чтобы установить переключатель, установите его так, чтобы один выступ находился спереди, а другой - сзади. Каждый штифт на нижней стороне переключателя должен точно указывать на соответствующий контакт в отверстие клавиатуры. Убедитесь, что переключатель направлен вертикально в отверстие (под углом 90 градусов). Неправильная установка переключателя может привести к его повреждению или неисправности. После того, как вы поместили переключатель в отверстие, очень осторожно нажмите на переключатель, чтобы зафиксировать его на месте. Убедитесь, что вы не применяете слишком много силы, так как это может повредить или сломать хрупкие компоненты.

TR

Anahtarları takmak için, anahtarın bir tırnak önde ve diğer tırnak arkada olacak şekilde konumlandırın. Anahtarın alt tarafındaki her bir pim, klavye soketindeki ilgili kontakta tam olarak işaret etmelidir. Anahtarın dikey olarak soket açıklığına yönlendirildiğinden emin olun (sokete 90 derecelik bir açıyla). Anahtarın yanlış takılması, anahtarın hasar görmesine veya arızalanmasına neden olabilir. Anahtarın yuvasına yerleştirdikten sonra, yerine sabitlemek için anahtarın oldukça nazik br şekilde itin. Çok fazla güç kullanmadığınızdan emin olun, çünkü bu, kırılabilir bileşenlere zarar verebilir veya yok edebilir.

CN

要安裝軸體，在放置軸體時請將一個卡榫朝前，另一個在後，軸體底部的每個針腳都應準確對準鍵盤插座上的接點，確保軸體垂直插入孔位（與插座呈90度）。不正確地安裝可能會造成軸體的損壞或故障，切勿太用力而損傷了易碎的零組件。

JP

スイッチを設置するために、1つ目のタブを前面に、もう一方のタブを後方になるようスイッチを設置します。スイッチの下にある各ピンは、キーボードソケットに関連する接点に正確にポイントニングをしている必要があります。スイッチがソケット開口部に垂直（ソケットの角度に対して、90度）に合わせているか確認してください。スイッチの誤った設置はスイッチの損傷や誤作動を引き起こす可能性があります。スイッチをソケットに設置した後、所定場所に固定するため、スイッチを再度、優しく押し込んでください。壊れやすいコンポーネントが破損や損傷する可能性があるため、力を入れすぎないようにしてください。

General:	SKILLER SGK50 S4 RED	SKILLER SGK50 S4 BROWN	SKILLER SGK50 S4 BLUE
■ Type:	Gaming Keyboard	Gaming Keyboard	Gaming Keyboard
■ Switch Technology:	Hot-Swap	Hot-Swap	Hot-Swap
■ Illumination:	RGB	RGB	RGB
■ Adjustable Illumination:	✓	✓	✓
■ Lighting Effects:	✓	✓	✓
■ Max. Polling Rate:	1,000 Hz	1,000 Hz	1,000 Hz
■ Block:	60 % Layout	60 % Layout	60 % Layout
■ Onboard Memory for Game Profiles:	✓	✓	✓
■ Capacity of Onboard Memory:	32 kB	32 kB	32 kB
■ Detachable Cable:	✓	✓	✓
■ Weight incl. / without Cable:	648 / 588 g	648 / 588 g	648 / 588 g
■ Dimensions (L x W x H):	29.3 x 10.3 x 3.8 cm	29.3 x 10.3 x 3.8 cm	29.3 x 10.3 x 3.8 cm
■ Supported Operating Systems:	Windows	Windows	Windows

Key Properties:

■ Function Keys with Preset Multimedia Actions:	✓	✓	✓
■ N-Key Rollover Support:	✓	✓	✓
■ On-The-Fly Macro Recording:	✓	✓	✓
■ Operating Force:	50 g	50 g	50 g
■ Switch Properties:	Linear	Tactile	Clicky
■ Distance to Actuation Point:	1.9 mm	1.9 mm	1.9 mm
■ Operating Life Cycles of Keys:	Min. 70 Million Keystrokes	Min. 70 Million Keystrokes	Min. 70 Million Keystrokes

Cable and Connectors:

■ Connector:	USB-C	USB-C	USB-C
■ Spiral Cable:	✓	✓	✓
■ Cable Length:	180 cm	180 cm	180 cm
■ Gold-Plated USB Plug:	✓	✓	✓

Package Contents:

SKILLER SGK50 S4, Extra Keycaps, Keycap Puller Tool, Switch Puller Tool, Manual, USB Cable (180 cm)

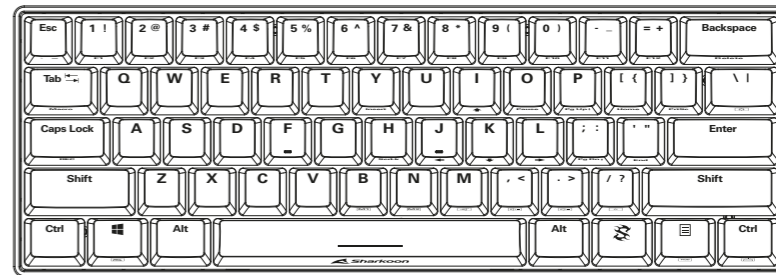
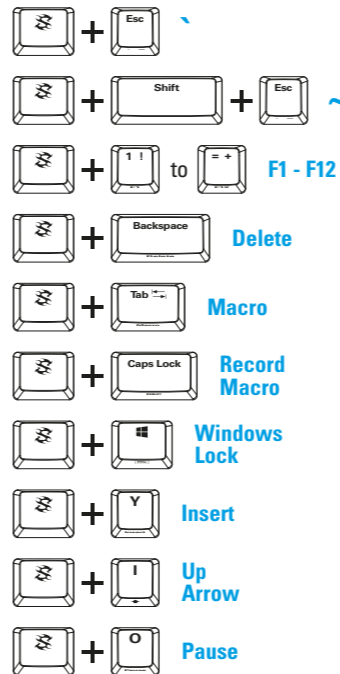



























































To set macros, first press and hold down the SKILLER function key and then press the Tab key. In the second step, first press and hold down the SKILLER function key and then press Caps Lock key. Once you have done this, the two macro buttons - B (M1) and N (M2) - will start flashing. Press and hold down the SKILLER function key and press one of these two macro keys to select it for macro recording. The macro key you selected will now start to light up continuously, while the macro key that has not been selected stops flashing. You can now start entering your macro actions. You can enter up to 16 individual actions. When you have reached the maximum number of actions, the selected macro key starts to flash, and the recording is automatically ended. However, if you would like to end the recording before all 16 available macro actions have been entered, first press and hold down the SKILLER function key and then press the Caps Lock key to end the recording.

Allgemein:	SKILLER SGK50 S4 RED	SKILLER SGK50 S4 BROWN	SKILLER SGK50 S4 BLUE
■ Typ:	Gaming-Tastatur	Gaming-Tastatur	Gaming-Tastatur
■ Schaltertechnologie:	Hot-Swap	Hot-Swap	Hot-Swap
■ Beleuchtung:	RGB	RGB	RGB
■ Anpassbare Beleuchtung:	✓	✓	✓
■ Beleuchtungseffekte:	✓	✓	✓
■ Max. Polling-Rate:	1.000 Hz	1.000 Hz	1.000 Hz
■ Block:	60 %-Layout	60 %-Layout	60 %-Layout
■ Onboard-Speicher für Spiel-Profile:	✓	✓	✓
■ Kapazität des Onboard-Speichers:	32 kB	32 kB	32 kB
■ Abnehmbares Kabel:	✓	✓	✓
■ Gewicht mit / ohne Kabel:	648 / 588 g	648 / 588 g	648 / 588 g
■ Abmessungen (L x B x H):	29,3 x 10,3 x 3,8 cm	29,3 x 10,3 x 3,8 cm	29,3 x 10,3 x 3,8 cm
■ Unterstützte Betriebssysteme:	Windows	Windows	Windows
Tasten-Eigenschaften:			
■ Funktionstasten mit voreingestellten Multimedia-Aktionen:	✓	✓	✓
■ N-Key-Rollover-Unterstützung:	✓	✓	✓
■ On-The-Fly-Makroaufnahme:	✓	✓	✓
■ Betätigungskraft:	50 g	50 g	50 g
■ Schaltercharakteristik-Eigenschaften:	Linear	Taktil	Clicky
■ Weg bis Schaltpunkt:	1,9 mm	1,9 mm	1,9 mm
■ Lebensdauer der Tasten:	Min. 70 Millionen Anschläge	Min. 70 Millionen Anschläge	Min. 70 Millionen Anschläge
Kabel und Anschlüsse:			
■ Anschluss:	USB-C	USB-C	USB-C
■ Spiralkabel:	✓	✓	✓
■ Kabellänge:	180 cm	180 cm	180 cm
■ Goldbeschichteter USB-Stecker:	✓	✓	✓

Verpackungsinhalt:

SKILLER SGK50 S4, Zusätzliche Tastenkappen, Tastenkappenzieher, Switch Puller Tool, Anleitung, USB-Kabel (180 cm)

-  +  **^**
-  +  +  **o**
-  +  bis  **F1 - F12**
-  +  **Entfernen**
-  +  **Makro festlegen**
-  +  **Makro aufzeichnen**
-  +  **Windowstaste sperren**
-  +  **Einfügen**
-  +  **Pfeil nach oben**
-  +  **Pause**
-  +  **Bild rauf**
-  +  **Pos1**
-  +  **Drucken**
-  +  **Rollen-Taste**
-  +  **Pfeil nach links**
-  +  **Pfeil nach unten**
-  +  **Pfeil nach rechts**
-  +  **Bild runter**
-  +  **Ende**
-  +  **Helligkeit erhöhen**
-  +  **Makrotaste 1 (M1)**
-  +  **Makrotaste 2 (M2)**
-  +  **Stumm(schalten)**
-  +  **Lautstärke verringern**
-  +  **Lautstärke erhöhen**
-  +  **Helligkeit verringern**
-  +  **Farbe des Lichteffekts ändern**
-  +  **Lichteffekt ändern**

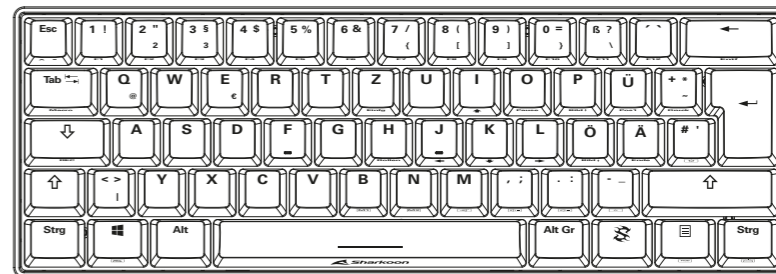

Um Makros festzulegen, drücken und halten Sie zunächst die SKILLER-Funktionstaste, und drücken Sie danach die Tabulatortaste. Drücken und halten Sie im zweiten Schritt zunächst die SKILLER-Funktionstaste, und drücken Sie danach die Feststelltaste. Sobald Sie das getan haben, beginnen die beiden Makrotasten – B (M1) und N (M2) – zu blinken. Halten Sie die SKILLER-Funktionstaste gedrückt und betätigen Sie eine dieser beiden Makrotasten, um diese für die Eingabe auszuwählen. Die von Ihnen ausgewählte Makrotaste beginnt nun durchgehend zu leuchten, währenddessen die nicht ausgewählte Makrotaste aufhört zu blinken. Jetzt können Sie mit der Eingabe Ihrer Makroaktionen starten. Sie können dabei bis zu 16 einzelne Aktionen eingeben. Haben Sie die Maximalzahl erreicht, beginnt die ausgewählte Makrotaste zu blinken und die Aufzeichnung wird automatisch beendet. Möchten Sie die Aufzeichnung jedoch vor Einstellung aller 16 verfügbaren Makroaktionen beenden, drücken und halten Sie zunächst die SKILLER-Funktionstaste, und betätigen Sie danach die Feststelltaste, um die Aufzeichnung zu beenden.

Caractéristiques générales:

	SKILLER SGK50 S4 RED	SKILLER SGK50 S4 BROWN	SKILLER SGK50 S4 BLUE
■ Type:	Clavier gaming	Clavier gaming	Clavier gaming
■ Technologie de commutation:	Hot-Swap	Hot-Swap	Hot-Swap
■ Eclairage:	RVB	RVB	RVB
■ Éclairage réglable:	✓	✓	✓
■ Effets de lumière:	✓	✓	✓
■ Taux d'interrogation max.:	1000 Hz	1000 Hz	1000 Hz
■ Bloc:	Configuration 60 %	Configuration 60 %	Configuration 60 %
■ Mémoire intégrée pour profils de jeu:	✓	✓	✓
■ Capacité de la mémoire intégrée:	32 kB	32 kB	32 kB
■ Câble amovible:	✓	✓	✓
■ Poids avec / sans câble:	648 / 588 g	648 / 588 g	648 / 588 g
■ Dimensions (L x P x H):	29,3 x 10,3 x 3,8 cm	29,3 x 10,3 x 3,8 cm	29,3 x 10,3 x 3,8 cm
■ Systèmes d'exploitation pris en charge:	Windows	Windows	Windows

Propriétés des touches:

■ Touches de fonction avec actions multimédia pré-configurées:	✓	✓	✓
■ Prise en charge de la frappe de coulée N touches:	✓	✓	✓
■ Enregistrement de macros à la volée:	✓	✓	✓
■ Force d'activation:	50 g	50 g	50 g
■ Propriétés du commutateur:	Linéaire	Tactile	Clic
■ Distance au point d'activation:	1,9 mm	1,9 mm	1,9 mm
■ Durée de vie opérationnelle des touches:	70 millions de frappes au clavier min.	70 millions de frappes au clavier min.	70 millions de frappes au clavier min.

Câbles et connecteurs:

■ Connecteur:	USB-C	USB-C	USB-C
■ Câble spirale:	✓	✓	✓
■ Longueur du câble:	180 cm	180 cm	180 cm
■ Fiche USB plaqué or:	✓	✓	✓

Contenu de l'emballage:

SKILLER SGK50 S4, Capuchons supplémentaires, Extracteur de capuchons, Outil d'extraction de commutateur, Manuel, Câble USB (180 cm)

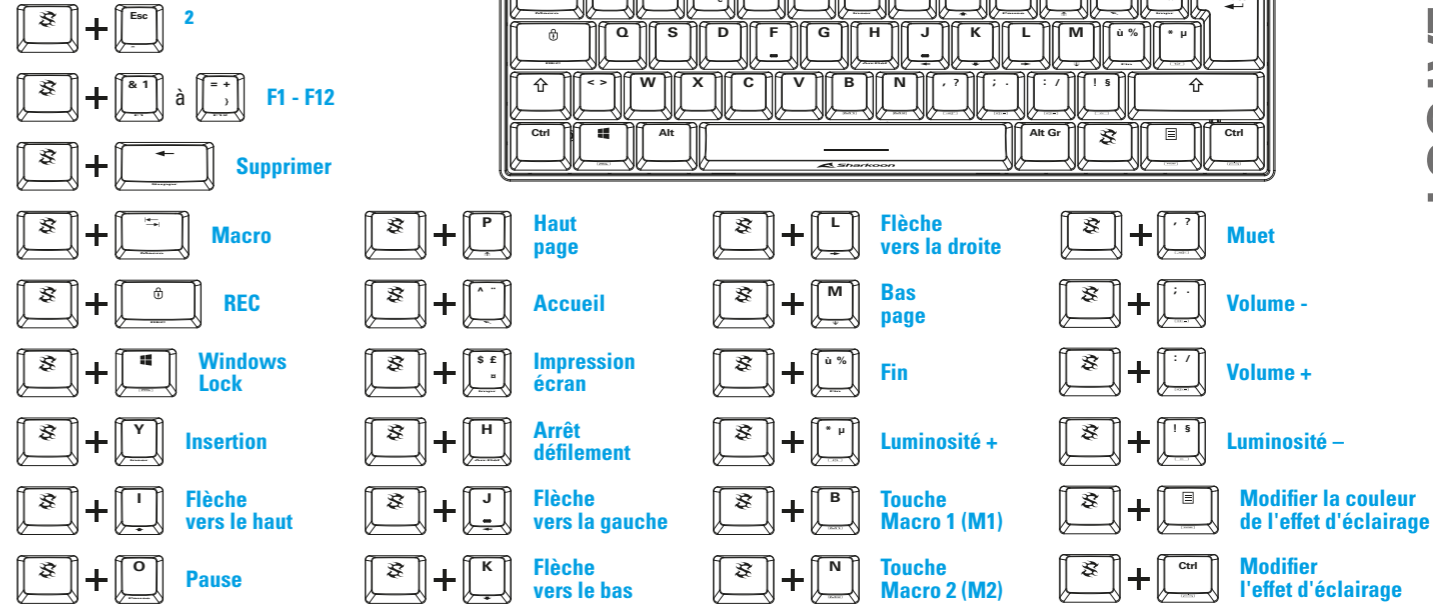

Pour définir des macros, appuyez d'abord sur la touche de fonction SKILLER et maintenez-la enfoncée, puis appuyez sur la touche de tabulation. Dans la deuxième étape, appuyez d'abord sur la touche de fonction SKILLER et maintenez-la enfoncée, puis appuyez sur la touche de verrouillage des majuscules. Une fois cela fait, les deux boutons macro - B (M1) et N (M2) - commenceront à clignoter. Appuyez et maintenez enfoncée la touche de fonction SKILLER et appuyez sur l'une de ces deux touches macro pour la sélectionner pour l'enregistrement de macro. La touche macro que vous avez sélectionnée va maintenant commencer à s'allumer en continu, tandis que la touche macro qui n'a pas été sélectionnée arrête de clignoter. Vous pouvez maintenant commencer à saisir vos actions de macro. Vous pouvez saisir jusqu'à 16 actions individuelles. Lorsque vous avez atteint le nombre maximum d'actions, la touche macro sélectionnée commence à clignoter et l'enregistrement est automatiquement terminé. Cependant, si vous souhaitez mettre fin à l'enregistrement avant que les 16 actions macro disponibles n'aient été saisies, appuyez d'abord sur la touche de fonction SKILLER et maintenez-la enfoncée, puis appuyez sur la touche Caps Lock pour terminer l'enregistrement.

Generale:	SKILLER SGK50 S4 RED	SKILLER SGK50 S4 BROWN	SKILLER SGK50 S4 BLUE
■ Tipo:	Tastiera da gioco	Tastiera da gioco	Tastiera da gioco
■ Tecnologia dello switch:	Rimuovibile	Rimuovibile	Rimuovibile
■ Illuminazione:	RGB	RGB	RGB
■ Illuminazione personalizzabile:	✓	✓	✓
■ Effetti illuminazione:	✓	✓	✓
■ Polling rate massimo:	1.000 Hz	1.000 Hz	1.000 Hz
■ Blocco:	Layout 60 %	Layout 60 %	Layout 60 %
■ Memoria integrata per i profili di gioco:	✓	✓	✓
■ Capacità della memoria integrata:	32 kB	32 kB	32 kB
■ Cavo rimovibile:	✓	✓	✓
■ Peso incl. / senza cavo:	648 / 588 g	648 / 588 g	648 / 588 g
■ Dimensioni (L x P x A):	29,3 x 10,3 x 3,8 cm	29,3 x 10,3 x 3,8 cm	29,3 x 10,3 x 3,8 cm
■ Sistemi operativi supportati:	Windows	Windows	Windows
Caratteristiche dei tasti:			
■ Tasti funzione con azioni multimediali predefinite:	✓	✓	✓
■ Supporta N-Key Rollover :	✓	✓	✓
■ Registrazione macro on-the-fly:	✓	✓	✓
■ Pressione tasto:	50 g	50 g	50 g
■ Caratteristiche dello switch:	Lineare	Tattil	Con feedback sonoro
■ Distanza dal punto di attuazione:	1,9 mm	1,9 mm	1,9 mm
■ Ciclo di vita dei tasti:	Minimo 70 milioni di battute per ogni tasto	Minimo 70 milioni di battute per ogni tasto	Minimo 70 milioni di battute per ogni tasto
Cavi e connettori:			
■ Connettore:	USB-C	USB-C	USB-C
■ Cavo a spirale:	✓	✓	✓
■ Lunghezza cavo:	180 cm	180 cm	180 cm
■ Connettore USB placcato in oro:	✓	✓	✓

Contenuto della confezione:

SKILLER SGK50 S4, Copritasti supplementari, Pinza per estrarre i copritasti, Pinza per estrarre gli switch, Manuale dell'utente, Cavo USB (180 cm)

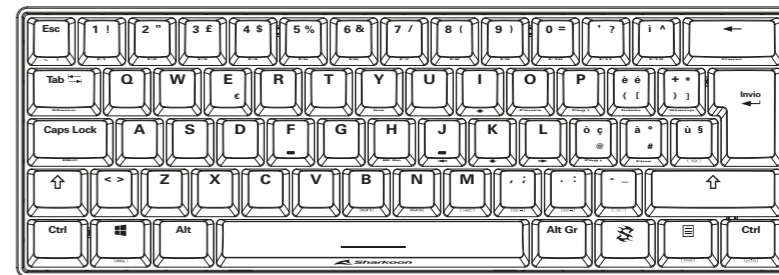
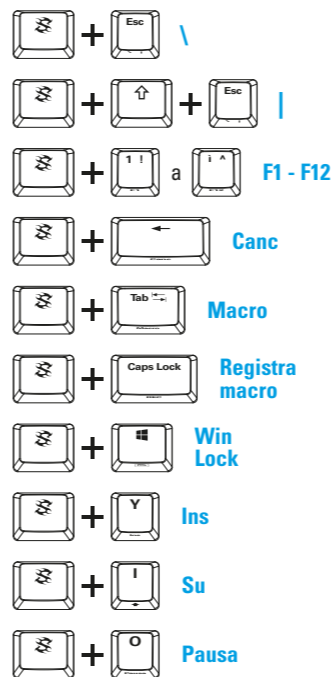























Per impostare le macro, tieni premuto il tasto SKILLER e premi il tasto Tab. Successivamente, tieni premuto il tasto SKILLER e premi il tasto Caps Lock. Esegui questi passaggi, i due tasti macro - B (M1) e N (M2) - inizieranno a lampeggiare. Tieni premuto il tasto SKILLER e premi uno dei due tasti macro per selezionarli e registrare una macro. Il tasto macro da te selezionato si accenderà in modo continuo, mentre quello non selezionato smetterà di lampeggiare. Ora puoi inserire le tue azioni macro. È possibile inserire fino a un massimo di 16 azioni individuali. Una volta raggiunto il numero massimo di azioni, il tasto macro selezionato inizierà a lampeggiare, mettendo automaticamente fine alla registrazione. Tuttavia, se vuoi terminare la registrazione prima di aver inserito tutte e 16 le azioni macro disponibili, tieni premuto il tasto SKILLER e premi il tasto Caps Lock.









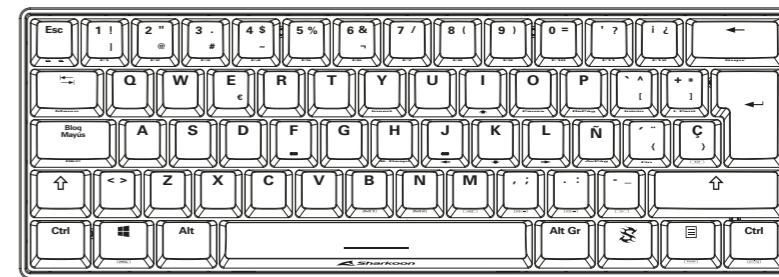



























General:	SKILLER SGK50 S4 RED	SKILLER SGK50 S4 BROWN	SKILLER SGK50 S4 BLUE
■ Tipo:	Teclado para juego	Teclado para juego	Teclado para juego
■ Tecnología de interruptor:	Cambio en caliente	Cambio en caliente	Cambio en caliente
■ Iluminación:	RGB	RGB	RGB
■ Iluminación graduable:	✓	✓	✓
■ Efectos de iluminación:	✓	✓	✓
■ Tasa máx. de sondeo:	1.000 Hz	1.000 Hz	1.000 Hz
■ Bloques:	Diseño en 60 %	Diseño en 60 %	Diseño en 60 %
■ Memoria integrada para perfiles de juego :	✓	✓	✓
■ Capacidad de la memoria integrada:	32 kB	32 kB	32 kB
■ Cable extraíble:	✓	✓	✓
■ Peso incl. / sin cable:	648 / 588 g	648 / 588 g	648 / 588 g
■ Dimensiones (L x An x Al):	29,3 x 10,3 x 3,8 cm	29,3 x 10,3 x 3,8 cm	29,3 x 10,3 x 3,8 cm
■ Sistemas operativos compatibles:	Windows	Windows	Windows
Propiedades de las teclas:			
■ Teclas de función con acciones multimedia predeterminadas:	✓	✓	✓
■ Soporte N-Key Rollover:	✓	✓	✓
■ Grabación de Macros on-the-fly:	✓	✓	✓
■ Fuerza operativa:	50 g	50 g	50 g
■ Propiedades del interruptor:	Lineal	Táctil	Clicky
■ Distancia al punto de actuación:	1,9 mm	1,9 mm	1,9 mm
■ Ciclos operativos de vida de las teclas:	Mín. 70 millones de pulsaciones	Mín. 70 millones de pulsaciones	Mín. 70 millones de pulsaciones
Cable y conectores:			
■ Conector:	USB-C	USB-C	USB-C
■ Cable en espiral:	✓	✓	✓
■ Longitud de cable:	180 cm	180 cm	180 cm
■ Conector USB chapado en oro:	✓	✓	✓

Contenidos del paquete:

SKILLER SGK50 S4, Casquetes de tecla extra, Extractor de casquetes, Extractor de interruptores, Manual, Cable USB (180 cm)



























































-  +  = **o**
-  +  +  = **a**
-  +  = **a**
-  +  = **F1 - F12**
-  +  = **Eliminar**
-  +  = **Macro**
-  +  = **Record Macro**
-  +  = **Windows Lock**
-  +  = **Insertar**
-  +  = **Flecha arriba**
-  +  = **Pausa**



-  +  = **RePág**
-  +  = **Flecha a la derecha**
-  +  = **Mutear**
-  +  = **Inicio**
-  +  = **AvPág**
-  +  = **Fin**
-  +  = **Record Macro**
-  +  = **Flecha a la izquierda**
-  +  = **Flecha abajo**
-  +  = **Subir volumen**
-  +  = **Bajar volumen**
-  +  = **Incrementar el brillo**
-  +  = **Disminuir el brillo**
-  +  = **Tecla Macro 1 (M1)**
-  +  = **Tecla Macro 2 (M2)**
-  +  = **Cambiar el efecto de iluminación**
-  +  = **Cambiar el color del efecto de iluminación**
-  +  = **Cambiar el efecto de iluminación**

Para configurar macros, primero presione y mantenga pulsada la tecla de función SKILLER y luego presione el tabulador. En un segundo paso, primero presione y mantenga pulsada la tecla de función SKILLER y luego presione la tecla bloqueo mayúsculas. Una vez hecho esto, empezarán a parpadear los dos botones macro - B (M1) and N (M2) -. Presione y mantenga pulsada la tecla de función SKILLER y presione una de estas dos teclas macro para seleccionarla para grabar un macro. La tecla macro que seleccionó empezará ahora a iluminarse de forma continua, mientras que la tecla macro que no se ha seleccionado parará de parpadear. Ahora puede empezar a realizar entradas y acciones de macro. Puede introducir hasta 16 acciones individuales. Cuando haya alcanzado el máximo número de acciones, la tecla macro seleccionada empezará a parpadear, y la grabación se parará automáticamente. Sin embargo, si desea terminar la grabación antes de haber introducido las 16 acciones macro disponibles, primero presione y mantenga pulsada la tecla de función SKILLER y luego presione la tecla bloqueo mayúsculas para finalizar la grabación.

Geral:	SKILLER SGK50 S4 RED	SKILLER SGK50 S4 BROWN	SKILLER SGK50 S4 BLUE
■ Tipo:	Teclado para jogos	Teclado para jogos	Teclado para jogos
■ Tecnologia Switch:	Hot-Swap	Hot-Swap	Hot-Swap
■ Iluminação:	RGB	RGB	RGB
■ Iluminação ajustável:	✓	✓	✓
■ Efeito de iluminação:	✓	✓	✓
■ Máximo Polling Rate:	1.000 Hz	1.000 Hz	1.000 Hz
■ Bloqueio:	Layout em 60 %	Layout em 60 %	Layout em 60 %
■ Memória onboard para perfis de jogo:	✓	✓	✓
■ Capacidade da memória onboard:	32 kB	32 kB	32 kB
■ Cabo Destacável:	✓	✓	✓
■ Peso incl. / sem cabo:	648 / 588 g	648 / 588 g	648 / 588 g
■ Dimensões (C x L x A):	29,3 x 10,3 x 3,8 cm	29,3 x 10,3 x 3,8 cm	29,3 x 10,3 x 3,8 cm
■ Sistemas operacionais suportados:	Windows	Windows	Windows
Propriedades do teclado:			
■ Função de teclas com ações multimídia predefinida:	✓	✓	✓
■ N-Key Suporte Rollover:	✓	✓	✓
■ On-The-Fly Gravação de macro:	✓	✓	✓
■ Força operacional:	50 g	50 g	50 g
■ Características dos interruptores:	Linear	Tátil	Clicky
■ Distância de atuação:	1,9 mm	1,9 mm	1,9 mm
■ Durabilidade das teclas:	Mínimo 70 milhões de pressionamentos	Mínimo 70 milhões de pressionamentos	Mínimo 70 milhões de pressionamentos
Cabo e conectores:			
■ Conector:	USB-C	USB-C	USB-C
■ Cabo Espiral:	✓	✓	✓
■ Comprimento do cabo:	180 cm	180 cm	180 cm
■ Plug USB banhado a ouro:	✓	✓	✓
Conteúdo da embalagem:	SKILLER SGK50 S4, Teclas extra, Ferramenta de extração das capas, Ferramenta Extrator de Interruptores, Manual, Cabo USB (180 cm)		

-  +  I
-  +  +  II
-  +  para  F1 - F12
-  +  Deletar
-  +  Macro
-  +  Gravar Macro
-  +  Windows Lock
-  +  Inserir
-  +  Seta para cima
-  +  Pause
-  +  Page Up
-  +  Home
-  +  Print Scr
-  +  Scroll Lock
-  +  Seta para esquerda
-  +  Seta para baixo
-  +  Seta para direita
-  +  Page Down
-  +  End
-  +  Aumentar Brilho
-  +  Tecla macro 1 (M1)
-  +  Tecla macro 2 (M2)
-  +  Mudo
-  +  Abaixar Volume
-  +  Aumentar Volume
-  +  Abaixar Brilho
-  +  Alterar a cor do efeito de iluminação
-  +  Alterar o efeito de iluminação

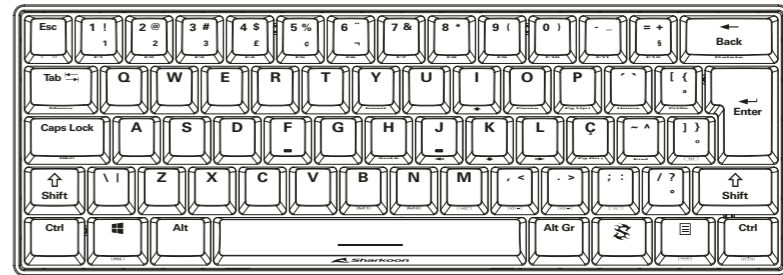

Para definir macros, primeiro pressione e segure a tecla de função SKILLER e depois pressione a tecla tab. Na segunda etapa, primeiro pressione e segure a tecla de função SKILLER e, em seguida, pressione a tecla Caps Lock. Depois de fazer isso, os dois botões macro - B (M1) e N (M2) - começarão a piscar. Pressione e segure a tecla de função SKILLER e pressione uma dessas duas teclas macro para selecioná-la para gravação de macro. A tecla macro que você selecionou começará a acender continuamente, enquanto a tecla macro que não foi selecionada para piscar. Agora você pode começar a inserir suas ações macro. Você pode inserir até 16 ações individuais. Ao atingir o número máximo de ações, a tecla de macro selecionada começa a piscar e a gravação é encerrada automaticamente. No entanto, se desejar encerrar a gravação antes que todas as 16 ações macro disponíveis tenham sido inseridas, primeiro pressione e segure a tecla de função SKILLER e, em seguida, pressione a tecla Caps Lock para encerrar a gravação.

Algemeen:	SKILLER SGK50 S4 RED	SKILLER SGK50 S4 BROWN	SKILLER SGK50 S4 BLUE
Type:	Gamingtoetsenbord	Gamingtoetsenbord	Gamingtoetsenbord
Technologie switches:	Hot-Swap	Hot-Swap	Hot-Swap
Verlichting:	RGB	RGB	RGB
Aanpasbare verlichting:	✓	✓	✓
Lichteffecten:	✓	✓	✓
Max. polling rate:	1.000 Hz	1.000 Hz	1.000 Hz
Blok:	60%-layout	60%-layout	60%-layout
Intern geheugen voor gameprofielen:	✓	✓	✓
Capaciteit van het intern geheugen:	32 kB	32 kB	32 kB
Afneembare kabel:	✓	✓	✓
Gewicht incl. / zonder kabel:	648 / 588 g	648 / 588 g	648 / 588 g
Afmetingen (L x B x H):	29,3 x 10,3 x 3,8 cm	29,3 x 10,3 x 3,8 cm	29,3 x 10,3 x 3,8 cm
Ondersteunde besturingssystemen:	Windows	Windows	Windows

Toets Eigenschappen:

Funcietoetsen met voorgeprogrammeerde multimedia-acties:	✓	✓	✓
N-Key Rollover ondersteuning:	✓	✓	✓
On-The-Fly Macro opname:	✓	✓	✓
Actuatiekracht:	50 g	50 g	50 g
Eigenschappen switch:	Lineair	Tactiel	Met klik
Afstand tot actuatiepunt:	1,9 mm	1,9 mm	1,9 mm
Levensduur van de toetsen:	Min. 70 miljoen aanslagen	Min. 70 miljoen aanslagen	Min. 70 miljoen aanslagen

Kabel en aansluitingen:

Aansluiting:	USB-C	USB-C	USB-C
Spiraalkabel:	✓	✓	✓
Kabellengte:	180 cm	180 cm	180 cm
Vergulde USB-stekker:	✓	✓	✓

Inhoud verpakking:

SKILLER SGK50 S4, extra keycaps, keycap puller tool, switch puller tool, handleiding, USB kabel (180 cm)

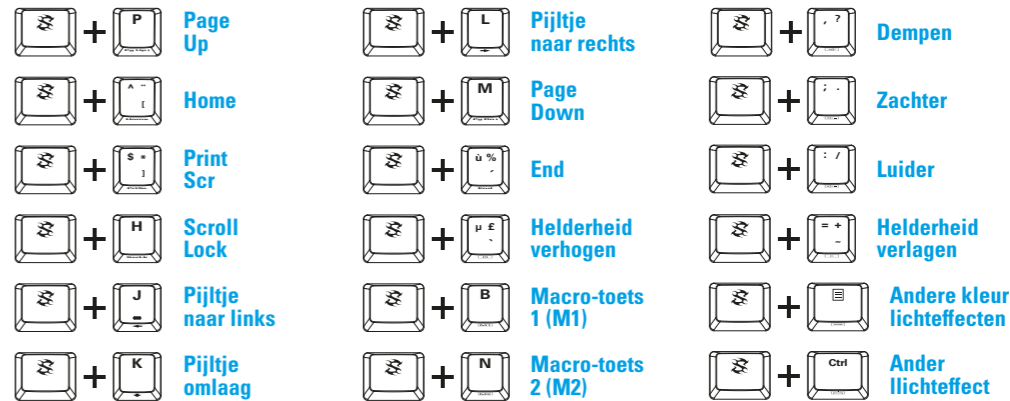
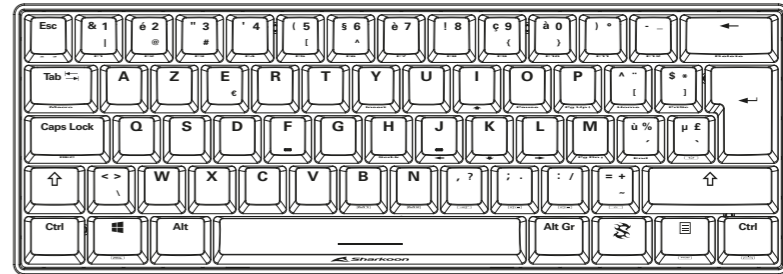
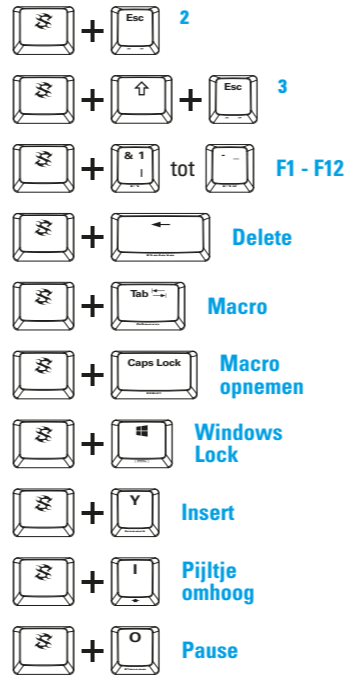

Om macro's in te stellen, houd je eerst de SKILLER-functietoets ingedrukt en druk je vervolgens op de tabtoets. In de volgende stap houd je eerst de SKILLER-functietoets ingedrukt en druk je vervolgens op de Caps Lock-toets. Als je dit hebt gedaan, beginnen de twee macrotoetsen - B (M1) en N (M2) - te knippen. Houd de SKILLER-functietoets ingedrukt en druk op een van deze twee macrotoetsen om die te selecteren voor het opnemen van een macro. De macrotoets die je hebt geselecteerd begint nu constant te branden, terwijl de macrotoets die niet geselecteerd is stopt met knippen. Je kunt nu beginnen met het invoeren van je macroacties. Je kunt maximaal 16 individuele acties invoeren. Als je het maximaal aantal acties hebt bereikt, begint de geselecteerde macrotoets te knippen en wordt de opname automatisch beëindigd. Maar als je de opname wilt beëindigen voordat alle 16 beschikbare macroacties zijn ingevoerd, houd je eerst de SKILLER-functietoets ingedrukt en druk je vervolgens op de Caps Lock-toets om de opname te beëindigen.

Ogólne:	SKILLER SGK50 S4 RED	SKILLER SGK50 S4 BROWN	SKILLER SGK50 S4 BLUE
■ Typ:	Klawiatura Gamingowa	Klawiatura Gamingowa	Klawiatura Gamingowa
■ Switche:	Hot-Swap	Hot-Swap	Hot-Swap
■ Podświetlenie:	RGB	RGB	RGB
■ Regulowane podświetlenie:	✓	✓	✓
■ Efekty podświetlenia:	✓	✓	✓
■ Odświeżanie USB:	1000 Hz	1000 Hz	1000 Hz
■ Układ:	60 %	60 %	60 %
■ Wbudowana pamięć na profile do gier:	✓	✓	✓
■ Wielkość wbudowanej pamięci:	32 kB	32 kB	32 kB
■ Odczepialny kabel:	✓	✓	✓
■ Waga z / bez kablem:	648 / 588 g	648 / 588 g	648 / 588 g
■ Wymiary (dł. x sz. x w.):	29,3 x 10,3 x 3,8 cm	29,3 x 10,3 x 3,8 cm	29,3 x 10,3 x 3,8 cm
■ Obsługiwane systemy operacyjne:	Windows	Windows	Windows

Właściwości klawiszy:

■ Klawisze z funkcjami multimedialnymi:	✓	✓	✓
■ Obsługa N-Key Rollover:	✓	✓	✓
■ Nagrywanie na żywo Makr:	✓	✓	✓
■ Siła nacisku:	50 g	50 g	50 g
■ Właściwości switchów:	Liniowy	Dotykowy	Clicky
■ Skok do punktu aktywacji:	1,9 mm	1,9 mm	1,9 mm
■ Cykl życia klawiszy:	Min. 70 milionów kliknięć	Min. 70 milionów kliknięć	Min. 70 milionów kliknięć

Kable i podłączenia:

■ Podłączenie:	USB-C	USB-C	USB-C
■ Kabel spiralny:	✓	✓	✓
■ Długość kabla:	180 cm	180 cm	180 cm
■ Połączane styki USB:	✓	✓	✓

Opakowanie zawiera:

SKILLER SGK50 S4, Dodatkowe klawisze, Narzędzie do wyciągania klawiszy, Narzędzie do wyjmowania switchy, Instrukcja, Kabel USB (180 cm)

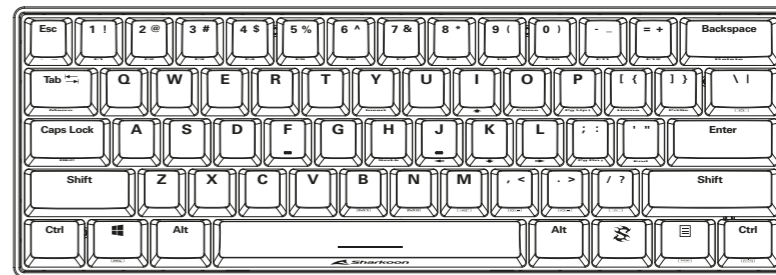
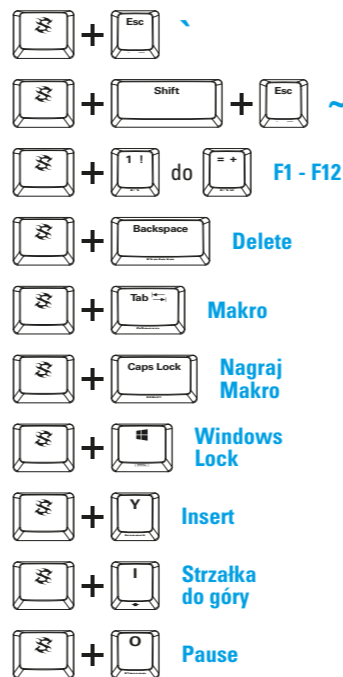

Aby ustawić makra, najpierw naciśnij i przytrzymaj klawisz funkcyjny SKILLER, a następnie naciśnij klawisz Tab. W drugim kroku najpierw naciśnij i przytrzymaj klawisz funkcyjny SKILLER, a następnie naciśnij klawisz Caps Lock. Gdy to zrobisz, dwa przyciski makro — B (M1) i N (M2) — zaczną migać. Naciśnij i przytrzymaj klawisz funkcyjny SKILLER i naciśnij jeden z tych dwóch klawiszy makr, aby wybrać go do nagrywania makr. Wybrany klawisz makro zacznie teraz świecić w sposób ciągły, podczas gdy klawisz makro, który nie został wybrany, przestanie migać. Możesz teraz rozpocząć wprowadzanie akcji makr. Możesz wprowadzić do 16 pojedynczych akcji. Po osiągnięciu maksymalnej liczby działań wybrany klawisz makro zacznie migać, a nagrywanie zostanie automatycznie zakończone. Jeśli jednak chcesz zakończyć nagrywanie przed wprowadzeniem wszystkich 16 dostępnych akcji makr, najpierw naciśnij i przytrzymaj klawisz funkcyjny SKILLER, a następnie naciśnij klawisz Caps Lock, aby zakończyć nagrywanie.

Általános:	SKILLER SGK50 S4 RED	SKILLER SGK50 S4 BROWN	SKILLER SGK50 S4 BLUE
■ Típus:	Gamer billentyűzet	Gamer billentyűzet	Gamer billentyűzet
■ Kapcsolótechnológia:	Hot-Swap	Hot-Swap	Hot-Swap
■ Megvilágítás:	RGB	RGB	RGB
■ Állítható megvilágítás:	✓	✓	✓
■ Világításeffektusok:	✓	✓	✓
■ Max. mintavételezési gyakoriság:	1000 Hz	1000 Hz	1000 Hz
■ Blokk:	60%-os kialakítás	60%-os kialakítás	60%-os kialakítás
■ Beépített memória játéprofilokhoz:	✓	✓	✓
■ A beépített memória kapacitása:	32 kB	32 kB	32 kB
■ Leválasztható kábel:	✓	✓	✓
■ Súly kábellel / kábel nélkül:	648 / 588 g	648 / 588 g	648 / 588 g
■ Méretek (H x Sz x M):	29,3 x 10,3 x 3,8 cm	29,3 x 10,3 x 3,8 cm	29,3 x 10,3 x 3,8 cm
■ Támogatott operációs rendszerek:	Windows	Windows	Windows

Fő tulajdonságok:

■ Funkcióbillentyűk előre beállított multimédiás műveletekkel:	✓	✓	✓
■ N-gombos rollover-támogatás:	✓	✓	✓
■ Menet közbeni makrófelvétel:	✓	✓	✓
■ Működési erő:	50 g	50 g	50 g
■ Kapcsoló tulajdonságai:	Lineáris	Tapintható	Kattanó
■ Távolság a működési pontig:	1,9 mm	1,9 mm	1,9 mm
■ Gombok működési élettartama:	Min. 70 millió leütéshez	Min. 70 millió leütéshez	Min. 70 millió leütéshez

Kábel és csatlakozók:

■ Csatlakozó:	USB-C	USB-C	USB-C
■ Spirálkábel:	✓	✓	✓
■ Kábelhossz:	180 cm	180 cm	180 cm
■ Aranyozott USB-csatlakozó:	✓	✓	✓

A csomag tartalma:

SKILLER SGK50 S4, Plusz cserebillentyűk, Billentyűkihúzó eszköz, Kapcsolókihúzó eszköz, Útmutató, USB kábel (180 cm)

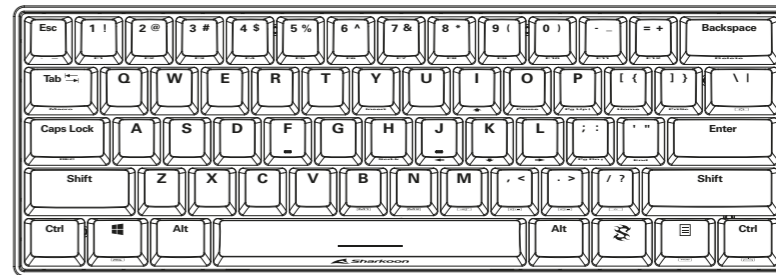
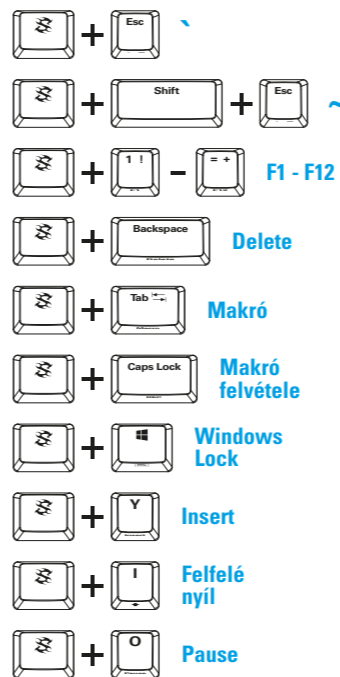

A makrók beállításához először tartsd lenyomva a SKILLER funkcióbillentyűt, majd nyomd meg a Tab gombot. A második lépésben először tartsd lenyomva a SKILLER funkcióbillentyűt, majd nyomd meg a Caps Lock gombot. Miután ez megvan, a két makrógomb – B (M1) és N (M2) – villogni kezd. Tartsd lenyomva a SKILLER funkciógombot, majd nyomd meg a két makrógomb egyikét: ezzel kijelölöd makrórögzítéshez. A kiválasztott makróbillentyű folyamatosan világítani kezd, míg a másik makróbillentyű abbahagyja a villogást. Most megadhatod a makrótevékenységeket. Akár 16 egyedi műveletet is megadhatsz. Ha elérted a műveletek maximális számát, a kiválasztott makrógomb villogni kezd, és a felvétel automatikusan befejeződik. Ha azonban mind a 16 rendelkezésre álló makróművelet megadása előtt be szeretnéd fejezni a felvételt, először nyomd meg hosszan a SKILLER funkciógombot, majd nyomd le a Caps Lock gombot a felvétel befejezéséhez.

Přehled:	SKILLER SGK50 S4 RED	SKILLER SGK50 S4 BROWN	SKILLER SGK50 S4 BLUE
■ Typ:	Herní klávesnice	Herní klávesnice	Herní klávesnice
■ Technologie spínačů:	Rychlá výměna	Rychlá výměna	Rychlá výměna
■ Nasvícení:	RGB	RGB	RGB
■ Nastavitelné osvětlení:	✓	✓	✓
■ Světelné efekty:	✓	✓	✓
■ Max. dotazovací frekvence:	1000 Hz	1000 Hz	1000 Hz
■ Blok:	60% rozvržení	60% rozvržení	60% rozvržení
■ Vnitřní paměť na herní profily:	✓	✓	✓
■ Kapacita paměti:	32 kB	32 kB	32 kB
■ Odpojitelný kabel:	✓	✓	✓
■ Hmotnost s kabelem / bez kabelu:	648 / 588 g	648 / 588 g	648 / 588 g
■ Rozměry (D x Š x V):	29,3 x 10,3 x 3,8 cm	29,3 x 10,3 x 3,8 cm	29,3 x 10,3 x 3,8 cm
■ Podporované operační systémy:	Windows	Windows	Windows

Klíčové vlastnosti:

■ Funkční klávesy s přednastavenými multimediálními akcemi:	✓	✓	✓
■ Podpora funkce N-key Rollover:	✓	✓	✓
■ Makro záznamy On-The-Fly:	✓	✓	✓
■ Operační síla:	50 g	50 g	50 g
■ Vlastnosti spínače:	Lineární	Dotykový	Klikací
■ Vzdálenost k bodu stisknutí:	1,9 mm	1,9 mm	1,9 mm
■ Operační životní cyklus kláves:	Min. 70 milionů úhozů	Min. 70 milionů úhozů	Min. 70 milionů úhozů

Kabel a konektory:

■ Konektor:	USB-C	USB-C	USB-C
■ Spirálový kabel:	✓	✓	✓
■ Délka kabelu:	180 cm	180 cm	180 cm
■ Pozlacená zástrčka USB:	✓	✓	✓

Obsah balení:

SKILLER SGK50 S4, Klávesy navíc, Kleštičky na klávesnice, Kleštičky na spínače, Příručka, USB kabel (180 cm)

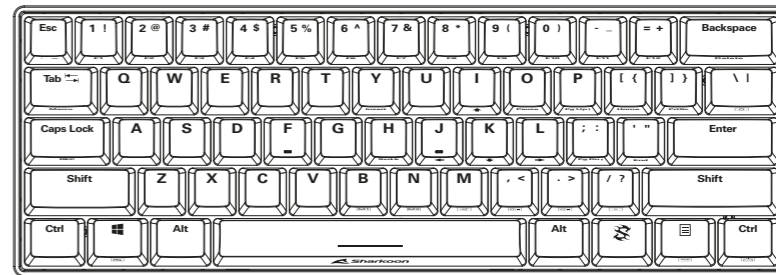
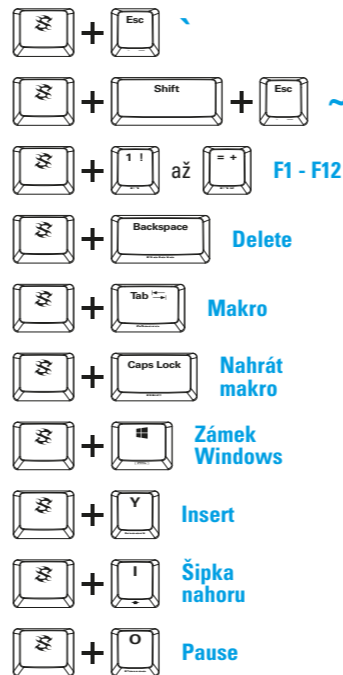

Makra nastavíte tak, že nejdřív stisknete a podržíte funkční tlačítko SKILLER a pak stisknete klávesu Tab. Ve druhém kroku nejdřív stisknete a podržíte funkční tlačítko SKILLER a pak stisknete klávesu Caps Lock. Až to uděláte, dvě tlačítka maker – B (M1) a N (M2) – začnou blikat. Stiskněte a podržte funkční tlačítko SKILLER a stiskněte jednu z těchto kláves maker, čímž zahájíte nahrávání makra. Zvolená klávesa makra nyní začne svítit trvale, zatímco nezvolená klávesa makra přestane blikat. Nyní můžete začít zadávat akce makra. Můžete zadat až 16 individuálních akcí. Po dosažení maximálního počtu akcí začne vybraná klávesa makra blikat a nahrávání se automaticky ukončí. Pokud byste však chtěli ukončit nahrávání před zadáním všech 16 dostupných akcí makra, stiskněte a podržte funkční tlačítko SKILLER a pak stiskněte klávesu Caps Lock, čímž nahrávání ukončíte.

Общее:	SKILLER SGK50 S4 RED	SKILLER SGK50 S4 BROWN	SKILLER SGK50 S4 BLUE
■ Тип:	Игровая клавиатура	Игровая клавиатура	Игровая клавиатура
■ Технология переключателей:	Hot-Swap	Hot-Swap	Hot-Swap
■ Подсветка:	RGB	RGB	RGB
■ Настраиваемая подсветка:	✓	✓	✓
■ Световые эффекты:	✓	✓	✓
■ Макс. частота опроса:	1 000 Гц	1 000 Гц	1 000 Гц
■ Компоновка:	60 %	60 %	60 %
■ Встроенная память для профилей игр:	✓	✓	✓
■ Объем встроенной памяти:	32 кБ	32 кБ	32 кБ
■ Съёмный кабель:	✓	✓	✓
■ Вес с / без кабелем:	648 / 588 г	648 / 588 г	648 / 588 г
■ Размеры (Д x Ш x В):	29,3 x 10,3 x 3,8 см	29,3 x 10,3 x 3,8 см	29,3 x 10,3 x 3,8 см
■ Поддерживаемые операционные системы:	Windows	Windows	Windows
Свойства клавиш:			
■ Удобные клавиши с предустановленными функциями управления мультимедиа:	✓	✓	✓
■ Поддержка N-Key Rollover:	✓	✓	✓
■ Создание быстрого макроса (во время игры):	✓	✓	✓
■ Сила срабатывания:	50 г	50 г	50 г
■ Характеристики переключателя:	Линейный	Тактильный	Кликающий
■ Расстояние до точки срабатывания:	1,9 мм	1,9 мм	1,9 мм
■ Жизненный цикл клавиш:	Мин. 70 миллионов нажатий	Мин. 70 миллионов нажатий	Мин. 70 миллионов нажатий
Кабели и разъемы:			
■ Разъем:	USB-C	USB-C	USB-C
■ Спиральный кабель:	✓	✓	✓
■ Длина кабеля:	180 см	180 см	180 см
■ Позолоченный штекер USB:	✓	✓	✓

Содержимое упаковки:

SKILLER SGK50 S4, дополнительные колпачки, ключ для снятия колпачков, инструмент для съёмки переключателя, руководство пользователя, кабель USB (180 см)

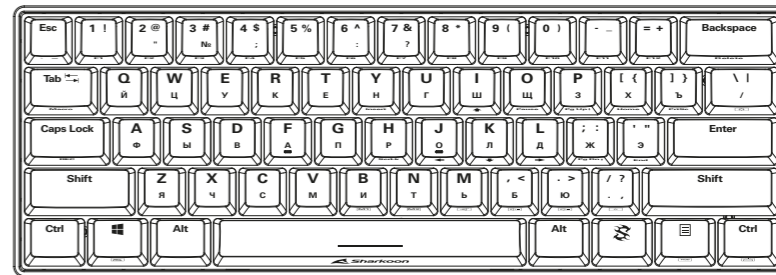

Чтобы установить макросы, сначала нажмите и удерживайте функциональную клавишу SKILLER, а затем нажмите клавишу TAB. На втором этапе сначала нажмите и удерживайте функциональную клавишу SKILLER, а затем нажмите клавишу Caps Lock. Как только вы это сделаете, две кнопки макроса - B (M1) и N (M2) - начнут мигать. Нажмите и удерживайте функциональную клавишу SKILLER и нажмите одну из этих двух клавиш макроса, чтобы выбрать ее для записи макроса. Выбранная вами макроклавиша начнет светиться постоянно, а невыбранная макроклавиша перестанет мигать. Теперь вы можете начать вводить свои макрокоманды. Вы можете ввести до 16 отдельных действий. Когда вы достигнете максимального количества действий, выбранная клавиша макроса начнет мигать, и запись автоматически завершится. Однако, если вы хотите завершить запись до того, как будут введены все 16 доступных макросов, сначала нажмите и удерживайте функциональную клавишу SKILLER, а затем нажмите клавишу Caps Lock, чтобы завершить запись.

Genel:	SKILLER SGK50 S4 RED	SKILLER SGK50 S4 BROWN	SKILLER SGK50 S4 BLUE
■ Tip:	Oyun Klavyesi	Oyun Klavyesi	Oyun Klavyesi
■ Anahtar Teknolojisi:	Hot-Swap	Hot-Swap	Hot-Swap
■ Aydınlatma:	RGB	RGB	RGB
■ Ayarlanabilir Aydınlatma:	✓	✓	✓
■ Işık Efektleri:	✓	✓	✓
■ Maks. Yanıt Süresi:	1.000 Hz	1.000 Hz	1.000 Hz
■ Blok:	60 % düzeni	60 % düzeni	60 % düzeni
■ Oyun Profilleri için Dahili Bellek:	✓	✓	✓
■ Dahili Bellek Kapasitesi:	32 kB	32 kB	32 kB
■ Çıkarılabilir Kablo :	✓	✓	✓
■ Kablo dahil / hariç Ağırlık:	648 / 588 g	648 / 588 g	648 / 588 g
■ Boyutlar (U x G x Y):	29,3 x 10,3 x 3,8 cm	29,3 x 10,3 x 3,8 cm	29,3 x 10,3 x 3,8 cm
■ Desteklenen İşletim Sistemleri:	Windows	Windows	Windows

Tuş Özellikleri:

■ Önceden Ayarlanmış Multimedya İşlemleriyle Fonksiyon Tuşları:	✓	✓	✓
■ N-Tuş Basım Desteği:	✓	✓	✓
■ Anında Makro Kayıt:	✓	✓	✓
■ Çalışma Kuvveti:	50 g	50 g	50 g
■ Anahtar Özellikleri:	Doğrusal	Dokunsal	Tıklamalı
■ Çalıştırma Noktasına Uzaklık:	1,9 mm	1,9 mm	1,9 mm
■ Anahtarların Çalışma Yaşam Döngüsü:	Min. 70 Milyon Tuş Vuruşu	Min. 70 Milyon Tuş Vuruşu	Min. 70 Milyon Tuş Vuruşu

Kablo ve Bağlantılar:

■ Bağlantı:	USB-C	USB-C	USB-C
■ Spiral kablo:	✓	✓	✓
■ Kablo Uzunluğu:	180 cm	180 cm	180 cm
■ Altın Kaplama Uçlu USB Fişi:	✓	✓	✓

Paket İçeriği:

SKILLER SGK50 S4, Ekstra klavye tuşları, Klavye tuş çıkartma aleti, Klavye tuş çıkartma aleti, El Kitabı, USB Kablo (180 cm)

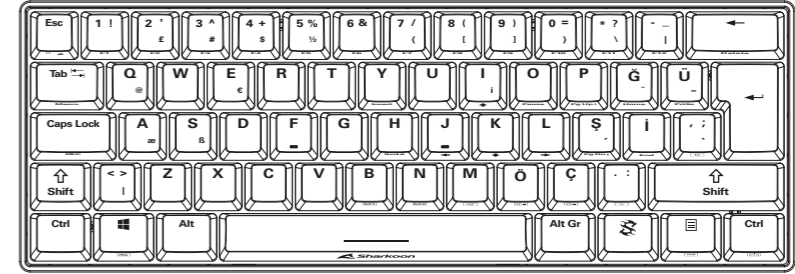
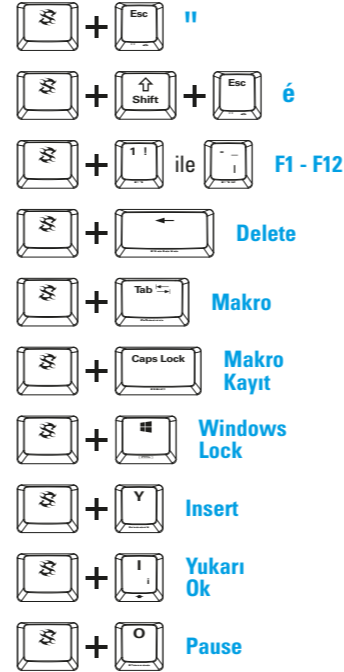

Makroları ayarlamak için önce SKILLER fonksiyon tuşunu basılı tutun ve ardından sekme tuşuna basın. İkinci adımda, önce SKILLER fonksiyon tuşunu basılı tutun ve ardından Caps Lock tuşuna basın. Bunu yaptığınızda, iki makro düğmesi - B (M1) ve N (M2) - yanıp sönmeye başlayacaktır. SKILLER fonksiyon tuşunu basılı tutun ve makro kaydı için seçmek için bu iki makro tuşundan birine basın. Seçtiğiniz makro tuşu artık sürekli olarak yanmaya başlayacak, seçili olmayan makro tuşu yanıp sönmeyi durduracaktır. Artık makro eylemlerinizi girmeye başlayabilirsiniz. 16 adede kadar bireysel işlem girebilirsiniz. Maksimum işlem sayısına ulaştığınızda seçilen makro tuşu yanıp sönmeye başlar ve kayıt otomatik olarak sonlandırılır. Ancak, mevcut 16 makro eyleminin tümü girilmeden önce kaydı bitirmek isterseniz, önce SKILLER işlev tuşunu basılı tutun ve ardından kaydı bitirmek için Caps Lock tuşuna basın.

Geral:	SKILLER SGK50 S4 RED	SKILLER SGK50 S4 BROWN	SKILLER SGK50 S4 BLUE
■ Tipo:	Teclado para jogos	Teclado para jogos	Teclado para jogos
■ Tecnologia Switch:	Hot-Swap	Hot-Swap	Hot-Swap
■ Iluminação:	RGB	RGB	RGB
■ Iluminação ajustável:	✓	✓	✓
■ Efeito de iluminação:	✓	✓	✓
■ Máximo Polling Rate:	1.000 Hz	1.000 Hz	1.000 Hz
■ Bloqueio:	Layout em 60 %	Layout em 60 %	Layout em 60 %
■ Memória onboard para perfis de jogo:	✓	✓	✓
■ Capacidade da memória onboard:	32 kB	32 kB	32 kB
■ Cabo Destacável:	✓	✓	✓
■ Peso incl. / sem cabo:	648 / 588 g	648 / 588 g	648 / 588 g
■ Dimensões (C x L x A):	29,3 x 10,3 x 3,8 cm	29,3 x 10,3 x 3,8 cm	29,3 x 10,3 x 3,8 cm
■ Sistemas operacionais suportados:	Windows	Windows	Windows

Propriedades do teclado:

■ Função de teclas com ações multimídia predefinida:	✓	✓	✓
■ N-Key Suporte Rollover:	✓	✓	✓
■ On-The-Fly Gravação de macro:	✓	✓	✓
■ Força operacional:	50 g	50 g	50 g
■ Características dos interruptores:	Linear	Tátil	Clicky
■ Distância de atuação:	1,9 mm	1,9 mm	1,9 mm
■ Durabilidade das teclas:	Mínimo 70 milhões de pressionamentos	Mínimo 70 milhões de pressionamentos	Mínimo 70 milhões de pressionamentos

Cabo e conectores:

■ Conector:	USB-C	USB-C	USB-C
■ Cabo Espiral:	✓	✓	✓
■ Comprimento do cabo:	180 cm	180 cm	180 cm
■ Plug USB banhado a ouro:	✓	✓	✓

Conteúdo da embalagem:

SKILLER SGK50 S4, Teclas extra, Ferramenta de extração das capas, Ferramenta Extrator de Interruptores, Manual, Cabo USB (180 cm)

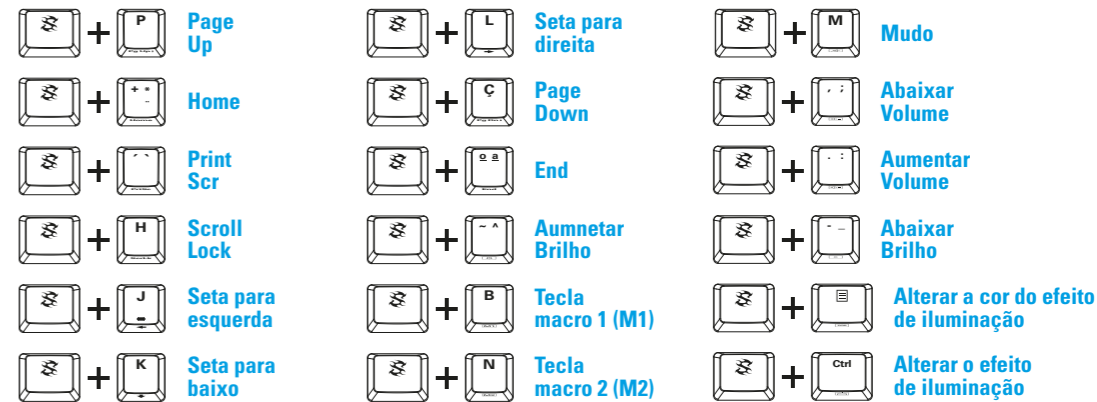
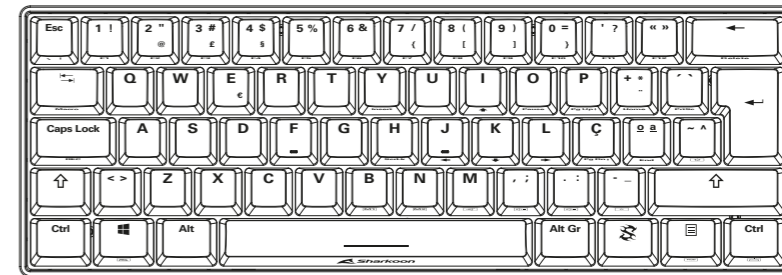
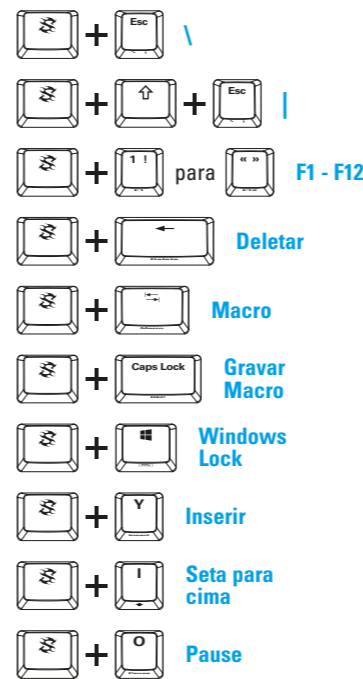

Para definir macros, primeiro pressione e segure a tecla de função SKILLER e depois pressione a tecla tab. Na segunda etapa, primeiro pressione e segure a tecla de função SKILLER e, em seguida, pressione a tecla Caps Lock. Depois de fazer isso, os dois botões macro - B (M1) e N (M2) - começarão a piscar. Pressione e segure a tecla de função SKILLER e pressione uma dessas duas teclas macro para selecioná-la para gravação de macro. A tecla macro que você selecionou começará a acender continuamente, enquanto a tecla macro que não foi selecionada para piscar. Agora você pode começar a inserir suas ações macro. Você pode inserir até 16 ações individuais. Ao atingir o número máximo de ações, a tecla de macro selecionada começa a piscar e a gravação é encerrada automaticamente. No entanto, se desejar encerrar a gravação antes que todas as 16 ações macro disponíveis tenham sido inseridas, primeiro pressione e segure a tecla de função SKILLER e, em seguida, pressione a tecla Caps Lock para encerrar a gravação.

基本資訊:	SKILLER SGK50 S4 RED	SKILLER SGK50 S4 BROWN	SKILLER SGK50 S4 BLUE
■ 類型:	電競鍵盤	電競鍵盤	電競鍵盤
■ 按鍵種類:	熱插拔	熱插拔	熱插拔
■ 發光功能:	RGB	RGB	RGB
■ 可調節發光功能:	✓	✓	✓
■ 背光效果:	✓	✓	✓
■ 最大採樣頻率:	1,000 Hz	1,000 Hz	1,000 Hz
■ 鍵盤區塊:	60 %	60 %	60 %
■ 可儲存遊戲設定檔的內建記憶體:	✓	✓	✓
■ 內建記憶體容量:	32 kB	32 kB	32 kB
■ 可拆卸式線材:	✓	✓	✓
■ 重量包含 / 不含線材:	648 / 588 g	648 / 588 g	648 / 588 g
■ 尺寸(長 x 寬 x 高):	29.3 x 10.3 x 3.8 cm	29.3 x 10.3 x 3.8 cm	29.3 x 10.3 x 3.8 cm
■ 支援作業系統:	Windows	Windows	Windows
按鍵特性:			
■ 內建多媒體功能鍵:	✓	✓	✓
■ 支援全鍵不衝突:	✓	✓	✓
■ 即時巨集錄製:	✓	✓	✓
■ 按壓力道:	50 g	50 g	50 g
■ 軸體特性:	線性	觸感	敲擊感
■ 觸發行程:	1.9 mm	1.9 mm	1.9 mm
■ 按鍵壽命:	大於 7000 萬次敲擊	大於 7000 萬次敲擊	大於 7000 萬次敲擊
線材和接頭:			
■ 接頭型式:	USB-C	USB-C	USB-C
■ 彈性捲線:	✓	✓	✓
■ 線材長度:	180 cm	180 cm	180 cm
■ 鍍金 USB 接頭:	✓	✓	✓
包裝內含物件:	SKILLER SGK50 S4, 額外的鍵帽, 拔鍵器, 拔軸器, 使用說明, USB 線材 (180 cm)		

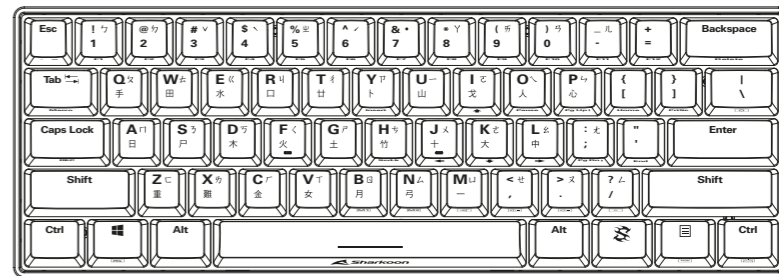
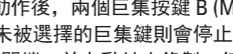
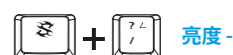
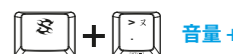
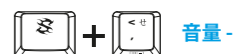
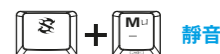
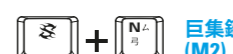
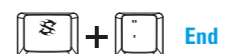
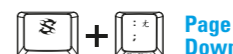
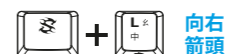
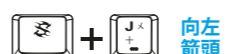
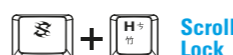
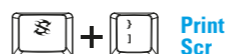
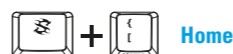
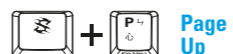
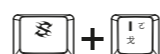
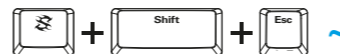
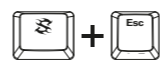

要設置巨集，請先按住 SKILLER 功能鍵，然後按 Tab 鍵。第二步，按住 SKILLER 功能鍵，再按 Caps Lock 鍵。完成此動作後，兩個巨集按鍵 B (M1) 和 N (M2) 會開始閃爍。按住 SKILLER 功能鍵同時按這兩個巨集鍵其中之一來選擇巨集錄製。你選擇的巨集鍵現在將持續亮燈，而未被選擇的巨集鍵則會停止閃爍。接下來就可以開始輸入你想要的巨集操作，最多可以輸入 16 個單獨的輸入，當達到最大輸入次數時，所選的巨集鍵就會開始閃爍，並自動結束錄製。但如果在輸入 16 個之前就結束錄製，請先按住 SKILLER 功能鍵，再按 Caps Lock 鍵來結束錄製。

基本情報:	SKILLER SGK50 S4 RED	SKILLER SGK50 S4 BROWN	SKILLER SGK50 S4 BLUE
■ タイプ:	ゲーミングキーボード	ゲーミングキーボード	ゲーミングキーボード
■ スイッチ技術:	Hot-Swap	Hot-Swap	Hot-Swap
■ イルミネーション:	RGB	RGB	RGB
■ 調整可能なイルミネーション:	✓	✓	✓
■ ライティング効果:	✓	✓	✓
■ 最大ポーリングレート:	1,000 Hz	1,000 Hz	1,000 Hz
■ ブロック:	60 % レイアウト	60 % レイアウト	60 % レイアウト
■ ゲームプロファイル保存用の内蔵メモリ:	✓	✓	✓
■ 内蔵メモリの容量:	32 kB	32 kB	32 kB
■ 取り外し可能なケーブル:	✓	✓	✓
■ ケーブルを含む / ケーブルを除く重量:	648 / 588 g	648 / 588 g	648 / 588 g
■ 寸法 (L x W x H):	29.3 x 10.3 x 3.8 cm	29.3 x 10.3 x 3.8 cm	29.3 x 10.3 x 3.8 cm
■ 対応 OS:	Windows	Windows	Windows

キーのプロパティ:

■ マルチメディア動作がプリセットされたファンクションキー:	✓	✓	✓
■ N キーロールオーバー対応:	✓	✓	✓
■ On-The-Fly マクロレコーディング:	✓	✓	✓
■ 作動力:	50 g	50 g	50 g
■ スイッチプロパティ:	リニア	タクトイル	クリックの感覚
■ 作動接点までの距離:	1.9 mm	1.9 mm	1.9 mm
■ キーの動作寿命:	最小 7000 万回のキーストローク	最小 7000 万回のキーストローク	最小 7000 万回のキーストローク

ケーブルとコネクタ:

■ コネクタ:	USB-C	USB-C	USB-C
■ スパイラルケーブル:	✓	✓	✓
■ ケーブル長さ:	180 cm	180 cm	180 cm
■ 金メッキ USB プラグ:	✓	✓	✓

パッケージ内容:

SKILLER SGK50 S4、エクストラキーキャップ、引き抜き工具、スイッチプーラーツール、マニュアル、USB ケーブル (180 cm)



半角/全角



F1 - F12

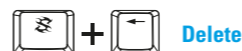

Delete

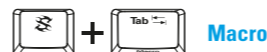

Macro



Record Macro



Windows Lock



Insert

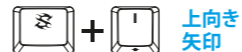

上向き矢印



Pause

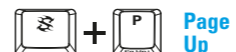

Page Up



Home



Print Scr

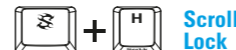

Scroll Lock

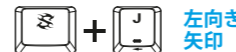

左向き矢印

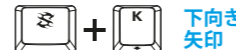

下向き矢印

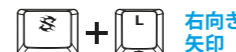

右向き矢印



Page Down



End



光度を上げる



マクロキー 1 (M1)



マクロキー 2 (M2)

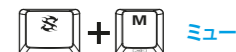

ミュート



ボリュームダウン



ボリュームアップ



光度を下げる



照明効果のカラーを変更する



照明効果を変更する

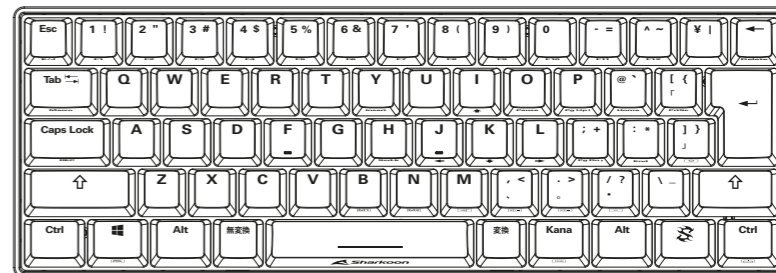

マクロスを設置するために、最初に SKILLER function key を押したままにしてから、tab キーを押してください。第二ステップでは、最初に SKILLER function key を押したままにしてから、Caps Lock key を押してください。一度こちらができれば、2つのマクロボタン B (M1) と N (M2) が発光をします。マクロを記録するためには、SKILLER function key を押したまま、上記のマクロキーの2つの中から1つを選び、押してください。選択したマクロキーが光り始めて、一方で選択していないマクロキーの点滅が止まります。これでマクロアクションの入力を開始することができます。アクションの最大数に達した時、選択されたキーは発光を始めて、記録は自動的に終了します。ただし、使用可能な16のマクロアクションを全て入力する前に、記録を終了させたい場合、最初に SKILLER function key を押したままにしてから、Caps Lock key を押して記録を終了させてください。



Follow us on     

Sharkoon Technologies GmbH
Grüninger Weg 48
35415 Pohlheim
Germany

© Sharkoon Technologies 2021

